

9-2010

The Effects of Homework on Student Achievement

Jennifer M. Hayward
The College at Brockport

Follow this and additional works at: http://digitalcommons.brockport.edu/ehd_theses

 Part of the [Education Commons](#)

To learn more about our programs visit: <http://www.brockport.edu/ehd/>

Repository Citation

Hayward, Jennifer M., "The Effects of Homework on Student Achievement" (2010). *Education and Human Development Master's Theses*. 120.

http://digitalcommons.brockport.edu/ehd_theses/120

This Thesis is brought to you for free and open access by the Education and Human Development at Digital Commons @Brockport. It has been accepted for inclusion in Education and Human Development Master's Theses by an authorized administrator of Digital Commons @Brockport. For more information, please contact kmyers@brockport.edu.

The Effects of Homework on Student Achievement

by

Jennifer M. Hayward

September 2010

A thesis submitted to the

Department of Education and Human Development of the

State University of New York College at Brockport

In partial fulfillment of the requirements for the degree of

Master of Science in Education

The Effects of Homework on Student Achievement

by

Jennifer M. Hayward

APPROVED BY:

Conrad Van Voorst

Advisor

9/2/10

Date

David Halverson

Director, Graduate Programs

9.2.10

Date

Table of Contents

Table of Contents	i
Chapter One: Introduction.....	1
Problem Statement.....	1
Purpose.....	2
Rationale.....	2
Definition of Key Terms.....	3
Summary.....	5
Chapter Two: Literature Review.....	7
Literature Search Procedures.....	7
History of Homework Research.....	9
Synthesis of Research.....	12
Gaps in the Research.....	20
Methodology.....	23
Chapter Three: Methods.....	26
Participants.....	26
Materials for Study.....	27
Data Collection.....	27
Data Analysis.....	29
Justification.....	30
Chapter Four: Results.....	32
Effects of Homework on Student Achievement.....	32
Student Feedback from Pre-Survey.....	43
Student Feedback from Post-Survey.....	51
Chapter Five: Discussions and Conclusions.....	57
Completed Homework Assignments.....	57
Assessment Scores vs. Completed Homework Assignments.....	58
Assessment Scores vs. Homework Scores.....	59
Student Opinions.....	61
Limitations of the Study.....	61
Implications for Practice.....	63
Future Research.....	64
Conclusion.....	64
References.....	66
Appendix A (Pre-Survey).....	69
Appendix B (Post-Survey).....	71
Appendix C (Pre-Intervention Quiz).....	72
Appendix D (Pre-Intervention Test).....	73
Appendix E (Post-Intervention Quiz).....	76
Appendix F (Post-Intervention Test).....	78

Chapter One: Introduction

The effect of homework on student achievement is a highly debated issue and has been for over a century. With our current educational system being compared to countries around the world, there has been a push to raise the standards in our schools so that we can compete in the global marketplace (Hyde, Else-Quest, Alibali, Knuth, & Romberg, 2006). One of the variables being scrutinized is homework. How much to give, how often to give it and what it should entail are all questions that researchers studying the homework-achievement relationship have strived to address. The question of how homework effects student achievement is an important one considering the ultimate goal as a teacher is for students to be successful and make an impact in the world. This study focuses on how completing and correcting homework affects student achievement in mathematics.

Problem Statement

The United States seems to lag behind the rest of the world in student success according to numerous studies that focus on student achievement scores (Baines, 2007). For example, looking at the results from the TIMMS and PISA studies, we can see that students in the United States are not performing at the same level as their international counterparts. The time students spend on academics outside of school is one way to increase student performance.

According to Paschal et al. (2001), the amount of home stimulation students receive can affect their achievement in school by as much as 50%. Homework is one way to increase the amount of time on task and promote student success. Homework assignments that are well-designed, well-planned and meaningful to students are most effective (Ellsasser, 2007). The purpose of homework needs to be explicitly clear to all students so that they can understand how it will help them succeed.

Purpose

The purpose of this study is to determine how implementing a homework correction plan affects student achievement in mathematics. There are numerous unique plans regarding homework that teachers use and often these varieties occur within the same school or district. Through my research, I found many recommendations for length of homework, the amount of time students should spend on homework, etc., but none that focused on having students make corrections to their homework. I believe if students are made aware of their misconceptions and have the opportunity to correct them on their homework assignments, the learning will carry over to their performance on assessments as well as their overall performance in mathematics.

Rationale

This study is important to the field of education for a number of reasons. First, at some point, most teachers will give some type of homework assignment to their students. Teachers need to be aware of the importance of designing meaningful homework and what to do with the homework when students complete it. Will it be collected, corrected, counted as a grade? Will students have the opportunity to make corrections or redo the assignment if it isn't satisfactory? These are all questions that should be considered and explained to students prior to giving an assignment.

Secondly, as educators, we want our students to be successful and as a nation, we want our students to be comparable to others around the world. We want to continue to research and learn about practices that make our students successful. If we didn't learn about the best practices regarding homework, students would be wasting valuable at-home time when learning is critical to student achievement (Paschal et al., 2001).

A prevalent type of study in the field of homework research investigates how the design of homework can effect student achievement. More specifically, whether homework is checked for completion, collected, graded, or if students evaluate their own homework can effect student achievement. De Jong, Westerhof, & Creemers (2000) found that simply checking homework was negatively related to student achievement. Similarly, Walberg, Paschal, & Weinstein (1985) found that teachers who collected, corrected, and graded homework found a stronger relationship between homework and achievement. When homework was graded or commented on, it raised learning from the 50th to the 79th percentile (Walberg et al., 1985). The literature supports the idea that when homework is collected and students are given feedback, it can result in positive effects on achievement.

Definition of Key Terms

Homework, as defined by Cooper (1989), is “any task assigned to students by school teachers that is meant to be carried out during nonschool hours” (p. 86). Cooper’s definition has been a common one throughout homework research (Cooper, Lindsay, Nye, & Greathouse, 1998; Cooper, Robinson, & Patall, 2006; Dettmers, Trautwein, & Ludtke, 2009). A slightly broader definition of homework by De Jong, Westerhof, and Creemers (2000) states homework is “performing school curriculum tasks outside regular school classes” (p. 132).

Although these definitions are very similar and have been used by many researchers studying homework, there seems to be questions that arise from them and gaps that need to be filled. For example, is it considered homework if a student completes an assignment from their first period class during their second period class? According to Cooper’s (1989) definition, the assignment was *meant* to be carried out during nonschool hours and so it would still be considered homework. To answer questions like this, it is important to note the exclusions from

Cooper's definition of homework, which were "in-school guided study, home study courses, and extracurricular activities" (1989, p. 86). In 2001, these exclusions from the definition of homework were made more specific stating, "in-school tutoring, nonacademic extracurricular activities (i.e. clubs, sports), or home study courses offered through mail, television, or other media" are not considered homework (Cooper & Valentine, p. 145). It was also clarified that "the phrase nonschool hours is used because students may complete homework during study halls, library time, or during subsequent classes" (Cooper et al., 2006, p. 1).

Keith (1982) defines homework as "the amount of time students spend studying outside of class" (p. 248). This definition does not fit with the others because it does not describe what homework is, rather it describes one specific variable of homework, which is time spent on completing it. For this reason, throughout this literature review homework will be defined as any task assigned to students by schoolteachers that is meant to be carried out during nonschool hours and excludes in-school tutoring, nonacademic extracurricular activities, or home study courses.

Another important, but ambiguous term in the literature, is "student achievement." There are two different uses of the term that are prevalent in the research. Student achievement can be defined as a student's score on a standardized test (Cooper, Valentine, Nye, & Lindsay, 1999; De Jong, Westerhof, & Creemers, 2000) or a student's grades in their classes (Keith, 1982; Bryan & Sullivan, 1998; Xu, 2009).

In fact, Trautwein, Koller, Schmitz, and Baumert (2001) point out that homework completed and time spent on homework have a much stronger influence on school grades than on standardized test scores. When comparing results from studies, it will be important to look at how they define student achievement. For example, in Xu's (2009) study, a student's level of

achievement was determined by their grades across all subjects. Another study that defined achievement as students' class grades placed their grades on a scale from one to eight that represented the most common letter grades they earned in their classes (Keith, 1982).

In my opinion, comparing student achievement in this way is useful across one teacher's classes, but not when comparing student achievement across the field. The results of these studies should be carefully reviewed because class grades are subjective and may vary from teacher to teacher. However, Keith argues that grades should be used rather than test scores because "grades are a more frequent measure of achievement and are readily interpretable by parents, students, and school personnel" (1982, p. 252).

In most of the literature, it is preferred that student achievement be defined as a student's score on a standardized test because it is then possible to compare results of a variety of studies. If the results of a study are based on class grades, those grades are subjective and may include other forms of assessment such as classwork or homework. We would not see a true reflection of student achievement and learning if class grades are not strictly comprised of test grades.

For the purpose of this study, student achievement will be measured by teacher-created classroom assessments. Since there is only one teacher in this study, we do not need to be concerned about inconsistencies when comparing students since they will have all taken the same assessments.

Summary

Homework is a topic that is discussed at length in educational research and there are so many facets to homework design that are important to consider. In this study, I will be implementing a homework plan that will encourage students to complete and correct their homework assignments and observe whether it can positively affect their achievement in math.

For example, students will hand in their homework assignment, I will correct it, provide feedback, and give them a score out of five points depending on their level of mastery. Students will then get their assignment back and have the opportunity to correct it both to earn a higher score and to reinforce concepts they may have struggled with. The students will be able to correct the assignment as many times as they would like until they attain mastery which would be a score of five. The question to keep in mind is: how does implementing a homework correction plan effect student achievement? The students would not be required to correct their homework. However, it would be highly encouraged because it will reinforce concepts which, in turn, would hopefully result in higher scores on their assessments.

Chapter Two: Literature Review

Literature Search Procedures

To review the research on the effect that homework has on student achievement, Education Research Complete was used as the primary database. The initial search included the terms “homework” and “achievement” and I did not narrow the search to include specific years. I wanted to find not only the most recent research on homework, but the oldest research I could find as well. This initial search resulted in 207 peer-reviewed articles from 1951 to 2009.

In an attempt to first find the oldest research on the effects of homework, I narrowed my search to include the years between 1951 and 1980. This resulted in seven articles and included one article that fit my criteria for inclusion. At this point in my search, my criteria for inclusion were fairly broad. I was looking for studies that investigated the question of how homework affects learning or achievement and if it did, I included it in my review. If it was too specific, such as focusing on a specific subject area or grade level or investigating methods to encourage students to complete homework, I excluded it from my review. Since there were so few articles during this timeframe, I thought it was appropriate to keep the inclusion criteria broad while keeping the initial questions in mind.

Although I had the starting point for my review of literature, I still had 29 years of research to sort through. To narrow my next search, I only included the years from 1980 to 2009 and added the term “effect” to my search criteria. This resulted in 37 peer-reviewed articles. I broadened my criteria for inclusion by accepting articles that were subject-specific, as long as they focused on mathematics. There were only two articles that I decided were worthy based on my criteria for inclusion. There was one article that I considered including, but decided against it after reading through the abstract and keeping my initial topic in mind. The article focused on

the effect homework had on undergraduate students' achievement, but I did not want to focus on college-level students. If it would have studied elementary, junior high or secondary students, I would have included it in my review.

Since I only found three articles worthy of inclusion at this point, I decided to again change my search criteria by broadening my search terms. Since the term "effect" seemed to narrow my results greatly, I used "homework," "achievement," but not "parent." I chose to exclude the term "parent" because many of the studies from my original search seemed to include parent involvement in homework and often looked at parents' level of education or socioeconomic status, but this is not what I wanted to focus on in my review. This search yielded 155 results and after reviewing their abstracts, I decided to use ten of them in my review.

The criteria used at this stage in my search were similar to my initial criteria of excluding articles that were too specific. For example, if an article focused on the effects of homework on students with special needs or students learning English as a second language, I excluded them from my review. One borderline article that was a result of this search studied the effect of homework in a rural versus urban school location. Although this was a very specific article in terms of the location of the schools, the results of the study proved to be important to what I hoped to include in my review. For this reason, I decided to include it.

My choice of topic lends itself to articles that are quantitative in nature, so I performed one last search to find articles that used qualitative methods. I searched the terms "homework" and "qualitative" to find two articles that fit my criteria for inclusion. However, even these two articles that used qualitative methods were both actually mixed-methods studies. In order to measure the effect that homework has on student achievement, the researchers found the need to include statistical data to support their claims.

As I began to read through each study and focus my research topic, I began to use the references of the articles I found helpful to extend my research base. Using this strategy, I was able to find researchers who were well-known in the field of homework research and this allowed me to add much breadth to my review. With a review of 21 peer-reviewed research articles, I am able to provide an extensive review of the literature.

History of Homework Research

Beliefs about the importance of homework have wavered over time. Prior to the 20th century, society felt that homework was meant to discipline children's minds (Cooper, Robinson, & Patall, 2006). The brain was seen as a muscle that needed to be exercised, mostly by memorizing important information. Since memorization was believed to be an at-home activity, homework was favorable among educators (Cooper, 1989).

However, by the start of the 20th century, society formed opposing opinions regarding homework's role in students' learning. In the January 1913 issue of *The Ladies Home Journal*, homework was described to be a waste of time and energy. Even medical doctors in this time period felt homework was unhealthy for students, claiming that it caused brain congestion and diverted blood that was needed for food digestion to go to the head. Some went as far as to say that having students carry textbooks home should be forbidden by law (Bryan & Sullivan-Burstein, 1998).

One of the first studies, conducted in 1927, compared homework to in-school study (Cooper & Valentine, 2001). The researchers examined the effects that each had on student achievement in a group of eleven and twelve year old students. This was the beginning of a vast future of homework research and public opinions that shifted between favorable and unfavorable numerous times over the years.

In the 1940s, the popular opinion was still that homework was useless and interfered with other at-home activities. It was believed that homework did not meet the basic needs of children and adolescents (Cooper, 1989). However, by the 1950s, after the Russians launched the Sputnik satellite, public opinion began to change toward favoring homework (Cooper, Robinson, & Patall, 2006). Americans felt that children were not being prepared in schools to face the technological advances that were happening in other countries. People started to stress the importance of homework, stating that it allowed students to acquire more knowledge and at a faster rate.

Surprisingly, public opinion changed once again as we passed into the next decade. The 1960s and 1970s were another period of strong feelings against homework. It was viewed as unnecessary pressure that would keep students from fulfilling other aspects of their personal lives (Cooper, 1989). Homework was said to have possible detrimental effects on students' mental well-being and its purpose and value was questioned (Cooper, Robinson, & Patall, 2006).

Entering the 1980s, Americans began to see test scores drop and again felt uneasy about how we compared to other countries (Cooper, Robinson, & Patall, 2006). Besides the decline in achievement, the report, *A Nation at Risk*, made Americans feel pressured to take another look at our educational system (Cooper, 1989). Keith (1982) stated that "public education is under scrutiny as never before and the public is finding its schools lacking. Given this climate of scrutiny and attack, it seems reasonable to expect that public schools and parents should renew their search for easily manipulable variables that will improve student achievement" (p. 248). One of the easily manipulable variables that society began to focus on was homework and the possibility of it improving student achievement. Educators began to look into the amount of homework and the different types of homework that could be given to students. They began to

analyze whether this was a worthwhile remedy or if the focus needed to be on educational policy and improvements in school quality (Trautwein, Koller, Schmitz, & Baumert, 2002).

At the turn of the 21st century, public perceptions of homework shifted once again. Parents began to express concern for their children and the amount of stress they were feeling (Cooper, Robinson, & Patall, 2006). At this point in time, there were a lot of mixed feelings by both educators and parents about the role of homework in children's education. The debates became more intense as people began to define their values related to education. The most recent discussions around education have focused on the idea that more time in school, more homework, more technology and more high-stakes testing will better prepare students to face the challenges of the 21st century (Baines, 2007).

Again, the spotlight is on global comparisons and striving to make American students rise to the standards of other countries. There are two major studies that compared student achievement at the international level. They were the Trends in International Math and Science Study (TIMSS) and the Programme of International Student Achievement (PISA) (Baines, 2007). In both cases, instructional strategies from high-achieving countries were reviewed in the hope that American schools could learn from their successes. Interestingly, Baines (2007) states that "instead of executing a strategy of more and more, some countries have decided to educate their young people by doing less" (p. 98).

Throughout history, the effect that homework has on student achievement has been an active investigation and it continues to be a source of debate among educators, parents, and educational policymakers. Just as public opinion has wavered over the years, researchers have also found opposing conclusions from studies conducted on the relationship between homework

and student achievement. It is an important issue to revisit as research evolves and as the global marketplace continues to advance.

Synthesis of Research

There have been numerous studies that investigate the effect that homework has on student achievement. Over the years, the studies have become more complex as researchers found that there were numerous variables that needed to be controlled in order to truly find how homework effects achievement. Some of the most basic studies compared the achievement of students given homework assignments with those who were not given any homework (Cooper, 1989; Cooper & Valentine, 2001; Trautwein, Koller, Schmitz, & Baumer, 2002; Dettmers, Trautwein, & Ludtke, 2009). In addition, these studies ensured that the students who were not assigned homework did not receive any other treatment that would compensate for the lack of at-home study time. The results of these studies showed that the groups of students given homework had a higher level of academic achievement than the students who were not given homework (Cooper, 1989; Cooper & Valentine, 2001; Trautwein et al., 2002).

In addition to these results, the studies found another important outcome that would become another facet of homework research. It was found that homework's effect on achievement was different depending on the grade level of the students. For students in high school, homework had the most influence on achievement level. For middle school or junior high students, the effect was half as much and for elementary students, there was little to no effect on achievement (Cooper, 1989; Cooper & Valentine, 2001).

This strong grade level correlation between the amount of time spent on homework and achievement was found in numerous studies. In the high school grades, students who spent more time on homework seemed to have higher levels of achievement. Most studies have found that a

positive correlation between time on homework and achievement for high school students did not appear until at least one hour per week was spent on homework (Cooper & Valentine, 2001). It was also found that for junior high school students, the optimal amount of time to spend on homework per week was less than one hour. The positive correlation disappears completely if students report spending between one and two hours each night on homework (Cooper & Valentine, 2001). In contrast, Cooper (1989) said that in the middle and junior high schools, students had increased achievement only when they spent between one and two hours a night on their homework rather than per week. After two hours of homework a night, they showed no increase in achievement. These findings are contradictory, but it seems to be the more recent research includes studies that support Cooper and Valentine's claim that the time spent weekly is the most influential. With elementary students, level of achievement was not affected by the amount of time spent on homework, just as assigning homework versus not assigning homework had little to no effect on achievement (Cooper & Valentine, 2001).

The continuous finding that homework is associated with achievement in secondary grades, but not in elementary grades is an important difference. Cooper and Valentine (2001) explain that younger children are less able to ignore stimulation in their environment, which may lead to homework's ineffectiveness at this age level. Also, younger children may not have the study habits needed to make homework a useful tool to increase achievement. An interesting point that Cooper and Valentine (2001) make is that teachers of younger students may assign homework that teaches study skills and time management rather than assignments that focus on content. This type of homework would not influence achievement because often students are not tested on their study habits and time management skills.

A second type of study prevalent in the research conducted on homework and achievement compared the amount of time students reported spending on homework with their achievement levels. Most of these studies used surveys or national assessments to collect their data. Many of the results were inconclusive because of the number of questionable variables that were not considered. For example, students who are generally high-achievers would probably spend more time on their homework for a few reasons. Perhaps they are taking a higher-level course such as an honors course that assigns more homework. Although they recorded spending more time on homework, they may have needed to because more was assigned (Epstein & Van Voorhis, 2001). This does not necessarily mean the amount of time they spent doing homework impacted their level of achievement. In this example, the variable of track or ability grouping would need to be controlled.

Second, high achieving students may spend more time on their homework in general because they want to do their best on each assignment. Spending a long time on homework may show that a student worked conscientiously (Dettmers et al., 2009). In contrast, low achieving students may report spending a lot of time on their homework because they struggle to complete it (Epstein & Van Voorhis, 2001). Spending more time on homework may show that a student has limited prior knowledge or poor study skills (Dettmers et al., 2009). Cooper and Valentine explain “students achieving at a lower level may take longer than higher achieving students to complete the same assignment. So, an increase in achievement by doing homework may be offset in correlational studies by the fact that poor-performing students also take longer to complete assignments” (2001, p. 148). So, although a student may report spending a lot of time on homework, it does not necessarily mean that is what caused a high level of achievement and vice versa. Although these types of results were not extremely prevalent, it needs to be

considered that there may be other factors influencing the amount of time students spend on their homework.

A study conducted in the Netherlands found a negative correlation between ability level and time spent on homework (De Jong, Westerhof, & Creemers, 2000). Students who had more prior knowledge, a higher level of intelligence, or better math grades, spent less time on homework. De Jong et al. (2000) claim that the time students reported spending on their homework was strongly influenced by their prior knowledge. Yet again, another variable in the homework research is identified. It is important to differentiate between these variables when relating time spent on homework to achievement (Dettmers et al., 2009).

In a study by Keith (1982), race, background, ability, and field of study were controlled. This was an important study in the field because it acknowledges the issue described previously where ability might influence how much time is spent on homework. His findings confirm that an increase in time spent on homework has a positive effect on a student's grades in high school. He found that the strongest effect on high school grades was from ability level. As expected, high-ability students earned better grades. However, even low ability students can earn higher grades. In fact, in this study, low ability students who spent one to three hours on homework each week, achieved grades comparable to an average ability student who did not spend any time on homework (Keith, 1982). Other researchers have also suggested that low-achieving students could benefit from spending more time on homework because they need more time to reach the same level as their high-achieving peers (Trautwein et al., 2002). On the other hand, some argue that homework assignments would be equally beneficial to students at all ability levels (Walberg, Paschal, & Weinstein, 1985).

Similarly, a study by Cooper, Valentine, Nye, and Lindsay (1999) found that students who reported spending more time on homework earned higher grades. In this study, prior test scores, student background, and other after-school activities were controlled. Although this study was different from Keith's study (1982) in that the achievement levels were determined by standardized achievement test scores rather than class grades, the results both show that an increase in achievement was prevalent. Interestingly, time spent on homework had a much stronger effect on school grades than on standardized test scores (Trautwein et al., 2002). There may be alternate explanations as to why there was a stronger effect on school grades such as the inclusion of homework completion in the students' grades. Therefore, if a student completes all homework assignments, they may have a higher class grade, but the results may have been different if comparing standardized test scores that do not include homework completion as part of the score.

A unique and contradictory opinion explained by Epstein and Van Voorhis (2001) is that students who spend little or no time on homework are unlikely to work harder or longer on an assignment just because more has been assigned. It is important to consider the purpose of a homework assignment and not just create an assignment that will take a certain amount of time to complete. Students who do not do their homework are less likely to do their homework if more is assigned just for the sake of more time on task.

A third type of study that is prevalent in the field is the frequency of homework and how it effects student achievement. Although not as prevalent as comparing time spent on homework to achievement, it is important to consider how often homework is given in addition to how long students spend completing it.

In a study by De Jong et al. (2000), most teachers assigned homework almost every lesson, which was three to four times a week (each class met four times per week). The results showed that frequency was not related to achievement. The amount of time students spent doing the homework assignments had a stronger relation (De Jong et al., 2000). Similarly, Cooper, Lindsay, Nye, and Greathouse (1998) found non-significant relationships between the frequency of homework assigned and average student achievement in elementary grades. In secondary grades, there was also a non-significant, but slightly negative relationship between frequency and achievement (Cooper, Lindsay, Nye, & Greathouse, 1998).

In contrast, a study was done by Trautwein et al. (2002) that found there was a significant relationship between classes that were assigned more homework and their achievement level. By the end of the school year, students who were assigned homework more frequently had higher scores than students who had homework less frequently. Students benefited from regular homework because they were practicing new concepts, previewing concepts to be learned, or reviewing previous concepts (Trautwein et al., 2002). Similarly, studies by Walberg, Paschal and Weinstein (1985; 2001) found that daily homework assignments resulted in larger effects on student achievement than homework assigned less often or assigned randomly. The highest effect sizes resulted when daily homework assignments were given.

Some researchers believe that the frequency of homework assignments per week is a variable that has been ignored in many studies and that homework frequency and time spent on homework should be treated as two separate variables in research (Trautwein et al., 2002). One of the largest studies conducted on homework research found that there is a positive association between schools with frequent homework and student achievement (Dettmers et al., 2009). Considering this study looked at 40 different countries and used a multilevel analysis, these

results are quite convincing. Dettmers et al. (2009) suggest that there be more studies in the future that distinguish between frequency of homework and time spent on homework because it could provide more insight into the effects on student achievement.

The last type of study that is prevalent in this field of research compares the design of homework assignments to student achievement. Within this type of study, there are a wide variety of design techniques that have been considered. The results of these studies are extremely important because they articulate how educators should create, implement and refine homework assignments to obtain the highest level of student achievement.

One of the first and possibly most important aspects of homework design is to create homework assignments that are interesting and engaging to students (Xu, 2009). When students are interested they are more likely to engage in a given task and are more likely to understand it and learn from it. Making an assignment engaging to students does not have to include their favorite hobbies and sports, but it should reflect their level of understanding and needs. Teachers must have an understanding of individual student's skills and abilities so that the assignments they create can help students meet their learning goals (Epstein & Van Voorhis, 2001).

In addition to making homework interesting and engaging, it must be meaningful. Homework is not meant to keep students busy and should not take up a substantial amount of class time to assign, collect, and correct (Ellsasser, 2007). To make homework meaningful, students could be involved in the design process or could reflect on why they are assigned certain assignments. For example, giving students a homework assignment that prepares them for the next class is time well spent (Ellsasser, 2007). Perhaps the assignment could be to read through a set of directions that the teacher would expect all students to come to class prepared to participate in an activity. Another type of assignment that is meaningful is one that covers

material from several days of lessons rather than material covered from one class (Cooper, 1989). This allows students to recall previous concepts while practicing new ones. These types of assignments are meaningful to students because they can see the purpose.

Another way to make homework assignments meaningful is to make them of high quality (Epstein & Van Voorhis, 2001). This can be done by carefully selecting the types of questions and number of questions on an assignment. Many teachers use worksheets and problems from a textbook for homework and this causes a student's level of engagement to decrease (Baines, 2007). Students can tell if a teacher has quickly put together an assignment for the sake of giving one. It is critical for teachers to invest the time to ensure homework assignments are related to the learning goals and can help advance students towards achieving those goals. Using the homework practices from the most current research can ensure assignments are meaningful (Brock, Lapp, Flood, Fisher, & Han, 2010). This is a teacher's professional responsibility (Epstein & Van Voorhis, 2001).

Another important part of homework design is whether homework assignments are checked for completion; collected, graded, or if students evaluate their own homework. As Ellsasser (2007) believes, minimal time in class should be spent assigning, collecting and correcting homework. However, De Jong et al. (2000) found that when time is devoted to giving homework during a lesson, it is positively related to achievement. It is important to note that the amount of time spent giving homework is low, but it still part of the lesson.

It was also found that simply checking whether homework is completed is negatively related to achievement (De Jong et al., 2000). However, just because checking homework was negatively related to achievement does not mean checking homework causes lower levels of achievement. It may be that teachers check homework of students who are low-achieving. Also,

in classes where students evaluate their own homework, student achievement was high (De Jong et al., 2000). Again, this is not a cause-effect relationship. It may be that teachers feel more comfortable allowing high-achieving students to correct their own homework.

Similar results were found in a study by Walberg et al. (1985) where teachers who collected, corrected, and graded homework, found a stronger relationship between homework and achievement. In fact, when homework is graded or commented on, it can raise learning from the 50th to the 79th percentile (Walberg et al., 1985). Additionally, teachers who collect, check and provide feedback on homework, show that homework is taken seriously and has a purpose (Cooper, 1989). Paschal et al. (2001) found similar results in their study because larger effects on achievement were found for homework that was graded and commented on by teachers.

In contrast, Trautwein et al. (2002) did not find the same conclusions. In their study, homework was monitored, but specifics of exactly what monitoring meant were not given. It could have meant homework was checked for completion, collected and graded, or maybe the students evaluated their own work. Since the method was not specified, it is difficult to compare conclusions.

Gaps in the Research

There are certainly gaps in the research on how homework effects student achievement. Researchers have been quite critical of these gaps and offer suggestions for future research in their studies. As more studies are conducted in the field, perhaps these gaps will be filled, but currently there are a number to be considered.

One of the gaps in current research are studies that compare the effect that homework has on student attitudes towards school and specific subjects (Cooper, 1989). Student achievement is effected by how a student feels about school or a specific subject. If a student dislikes school,

they probably won't have any interest in completing homework assignments because once they are out of school, they don't want to think about their schoolwork.

Conversely, there are students who are high achieving and do not feel the need to complete homework assignments because they continue to do well without completing them. There are students like this in every class. They achieve high scores on assessments, but their grade suffers due to lack of homework completion. Knowing and understanding the relationship between student attitudes and achievement can give educators insight about the homework achievement relationship and therefore is critical to investigate (Cooper, Linsay, Nye & Greathouse, 1998).

Closely related to the idea of researching student attitudes, is investigating whether students understand the purpose of homework and if they value homework completion (Cooper & Valentine, 2001). If we know what students understand about homework, we may be able to understand their motivation for doing homework or the effort they put into their performance on homework.

There are numerous purposes of homework including practice, preparation, participation, personal development, parent-child relations, parent-teacher communications, and peer interactions (Epstein & Van Voorhis, 2001). There are also some purposes that are not in the best interest of student achievement, such as to fulfill school policies about homework, to show a school has a rigorous program, or to punish students (Epstein & Van Voorhis, 2001).

Just like any other aspect of education, students need to understand why they are learning something and how it will benefit them when they enter the real world. If students do not see the purpose behind the assignments that they are required to complete outside of school, during their time at home, it seems unlikely they would have the motivation to complete these assignments.

So, although the purposes of homework have been discussed in the literature and may be clear to educators, it is important to look at the students' perceptions and understandings of these purposes.

Another interesting aspect that has been left out of homework research is how homework affects nonacademic outcomes such as study habits (Cooper, 1989). As the literature has shown, student achievement in elementary grades is not related to time spent on homework or frequency of homework. However, there have not been any studies that investigate whether homework can teach elementary students about time management and study skills (Cooper, Lindsay, Nye, & Greathouse, 1998). There must be a time when students begin to learn about these important skills and it seems as though the elementary grades would be an appropriate time. If students are not benefiting from curriculum-related homework, then maybe they could benefit from time management-related homework.

It seems obvious that homework given at the secondary level would improve students' study habits, but the lack of research to support this assumption is important to note. Students in higher grades are more likely to encounter multiple assignments or projects since they have more than one teacher and having the time management skills to complete these assignments on time is critical. Perhaps future research should focus not only on how homework effects achievement, but how homework can improve time management skills at the secondary level. After all, once students leave high school and enter college, it is expected that their time management skills have already been refined and can be applied to a non-structured environment.

Of course there are many more gaps and studies that can be conducted in the field of homework research, but more variables can always be identified to investigate in any field. After reviewing the literature, these gaps seemed to be the most prevalent and concerning. In my

opinion, the most crucial gap to fill is student understanding of the purpose and value of homework. It makes sense that if students understand how homework can affect their achievement, their attitude towards homework would improve and their time management skills would be refined. I think focusing on this in future research would help to fill a number of the prevalent gaps in the field.

If educators, at the start of the school year, can clearly describe the reasons behind assigning homework, students would have a general idea as to why they are being asked to complete homework. As each assignment is given, teachers should then begin to describe their purpose whether it is to practice what was taught in class, to review concepts from earlier in the year, or to work together with their peers or family. I believe it would be beneficial for educators to clarify their reasons for assigning homework because it would force them to align each assignment to their learning goals. It would also benefit the students because they could see that the assignment is meaningful and wasn't put together to fill their time at home.

Methodology

Comparing homework to student achievement seems to lend itself to quantitative methods for a number of reasons. First, researchers need to use statistical measures to compare either the amount of time spent on homework or frequency of homework to achievement scores. Most studies used correlations to do this and the results were clearly shown using these methods. Secondly, in many studies, countries, school districts, or classes within a school were being compared and so looking at the mean and standard deviation were important quantitative aspects. It made it relatively easy to compare student achievement across various countries using quantitative methods (Cooper et al., 2006; Dettmers et al., 2009).

Conversely, some studies that compared the design of homework to student achievement used more of a qualitative method or mixed-method approach. In these cases, researchers were using surveys, questionnaires or interviews to look at homework design, but then also looked at achievement scores and found possible correlations. Cooper et al. (1999) used questionnaires to find how much time was being spent doing homework after school and then this information was correlated to the students' test scores and class grades. Although a questionnaire was used to collect the data, typically a qualitative instrument, the data was then correlated to achievement test scores and used to form quantitative results (Cooper et al., 1999).

Both research methods adequately addressed the topic of how homework effects student achievement. It seems as though it would be difficult to perform a study that uses strictly qualitative methods because at some point, the data would need to be compared to standardized test scores or class grades since that is the focus of this topic.

However, looking at the gaps in the research and where the state of the field should be headed, more qualitative methods would help alleviate these gaps. For example, to begin research on student attitudes towards homework, it would be necessary to survey students on their current attitudes about homework as well as their attitudes after implementing purposeful homework assignments (Hyde et al., 2007). The results of these surveys would give researchers a great deal of information without using quantitative methods. I do believe that if researchers wanted to compare these results to student achievement levels, they would need to use a mixed-methods approach so that we could clearly see the correlation between attitude and achievement.

The effects of homework on student achievement encompass an immense amount of research. Over time, public opinion about homework has changed quite often. Research has given educators much insight into best practices, but there are still questions that remain

unanswered and variables that still need to be addressed. In the race to keep up with other countries in our educational system, it seems that student achievement has become a popular topic. Homework is just one possible variable to consider in this issue. Although considering it has been controversial over the last century, it is crucial that we continue to evaluate its influence on student achievement. More importantly, we must recognize how we can improve homework to maximize its effect on student achievement.

Chapter Three: Methods

Participants

This research study was conducted with a group of seventh grade students at a school district in New York State. This district is a prosperous, suburban school district with a high level of parental and community involvement and support. The class consists of 21 students; 10 girls and 11 boys. Seven of these students have 504 plans and receive extra reading and writing support either on a daily basis or every other day schedule.

The students are in a fourth period seventh grade math class. The study is being conducted towards the end of the school year and students are accustomed to the routines and procedures of the classroom. There is a set curriculum that all teachers follow, but there is no textbook so all materials are teacher-created. Therefore, unit assessments vary by teacher. Students have access to basic scientific calculators and there is a Smart Board and projector in the classroom.

During this study, the students completed two new units. The first unit was the baseline unit where students completed homework as usual with no option to correct their assignments. This unit focused on area, surface area and volume. The students needed to find the area, surface area and volume of given figures and they often needed to manipulate the formula to solve for a side length. In addition, students were given problems where they needed to find the area of the shaded region.

The second unit is when the homework correction plan was introduced and students had the option of improving their score on homework assignments by making corrections and resubmitting their assignments. This unit focused on ratios, rates, proportions and percents. The

students were asked to use a proportion to solve word problems involving commission and percent of change.

I am both the researcher and classroom teacher in this study. This is my fourth year teaching and all of my experience has been at the middle level. I have taught in a team setting for the last two years and have taught a variety of different courses including AIS math through Integrated Algebra with a Regents examination. My undergraduate degree is in Mathematics and Adolescent Education from SUNY Brockport and this study is the culmination of my graduate degree from SUNY Brockport.

Materials for Study

The materials used in this study included pre and post-surveys (Appendix A and B) questioning students about the importance of homework, completing homework corrections and if they felt there was a relationship between homework and their grade on assessments. There were ten questions on the pre-survey and six questions on the post-survey. They consisted of Likert-scale questions, written response questions, and questions where students were asked to check all that applied.

In addition, there were numerous homework assignments, a quiz (Appendix C) and a test (Appendix D) that were used for data collection for this study. The homework assignments varied in length, but all consisted of short response or short answer questions. The quiz and test follow similar formats. Again, all materials used in this study were teacher-created.

Data Collection

To begin the study, homework completion was recorded as usual meaning students were given a score out of two points. Two points were given if a student completed the assignment with good effort, one point was given if an assignment was only partially complete or completed

with little effort, and zero points were given if the assignment was not completed at all or with no effort. The students received feedback on their homework, but did not have the opportunity to make corrections. They took a quiz and test during this baseline unit.

The next unit was the start of the homework plan intervention. To begin, students were given the pre-survey. The pre-survey consisted of ten questions, three of which were Likert-scale questions, three had students check all answers that applied, two were yes/no questions, and two were written response questions. The pre-survey questioned students about the importance of homework, completing homework corrections and if they felt there was a relationship between homework and their grade on assessments.

Next, the new homework plan was introduced and students had the opportunity to ask questions. Each day, students completed a homework assignment and then handed it in the following day. The teacher corrected each assignment and all scores were converted to a five-point scale where a five represented mastery of the content (85% or higher). The assignments were handed back either the following day or two days after handing it in. This provided timely feedback and left students enough time to make corrections before the next assessment.

If students corrected a homework assignment, they handed it back in to the teacher and their original grade was kept with their new score recorded alongside it. It was also noted whether homework assignments were handed in late. This could be important when analyzing the results and making conclusions from the study.

During the post-intervention unit, a quiz was given and at the end of the unit, a test was given. The formats were similar to that of the homework assignments which were mostly short response. The scores from the quiz and test were kept as a percentage grade.

The final part of the data collection was the post-survey which was only six questions and asked students similar questions to the pre-survey, but focused on the impact of homework corrections. Three of the questions were Likert-scale questions, one of the questions was a yes/no question, and two of the questions were written response. I felt the post-survey should be shorter than the pre-survey because I wanted to focus specifically on the students' feelings towards correcting their homework and how they felt it affected their performance on their assessments. The post-survey was given after the unit test.

Data Analysis

To determine whether homework corrections had an effect on student achievement I compared a number of variables. First, using the pre-intervention unit data, I compared the percent of homework assignments completed to the corresponding quiz and unit test score. For example, there were a total of nine homework assignments leading up the unit test, so I converted the number of completed homework assignments to a percent and compared that to the unit test score. I compared the same variables for the post-intervention unit.

Next, for the post-intervention unit, I compared the average score of the completed assignments to the average score of those same completed assignments after they had been corrected by students. I thought this would be an important comparison to see how many students actually corrected their homework assignments and what they raised their score to. I then compared the corrected homework average to the students' quiz and test scores to see if there was a correlation.

Lastly, I compared the scores from the pre-intervention and post-intervention quiz and unit test. This comparison was most critical to the study because it focused on answering the research question of whether or not correcting homework assignments affected student

achievement. By comparing each student's quiz and test score from both units, we can see patterns and make conclusions based on the data.

To compare the variables mentioned above, I used Microsoft Excel to organize the data, create graphs, and find important statistical measures to help analyze the information. The mean, median, standard deviation and correlation were the statistical measures I thought would be most helpful in drawing conclusions from the data.

To analyze the data from the pre and post-surveys, I created charts and graphs to summarize the student responses from each question. For each individual question, I compiled the number of student responses and created a visual to compare it with the other student responses. It was clear from these visuals how most students felt about each of the topics that the surveys focused on.

Justification

The methods I chose to collect and analyze the homework and assessment data were the most appropriate methods to answer my research question. I felt that although only a few comparisons were necessary to answer the research question, there were other important variables to analyze in order to make accurate conclusions. For that reason, I decided it was important to include analyses of not only the percent of homework assignments students completed, but the score they received on those assignments both prior to corrections and after corrections were made. I thought this information would be very informative and help to draw important conclusions regarding the effect on student achievement.

The methods I chose to collect and analyze the survey data made it easy to compile the responses and display them for easy reading. Since there were 21 students in the study, which is

a fairly small number, it was manageable to sort through their responses in detail and categorize them accordingly.

Chapter Four: Results

To analyze the results of this study, I first looked at the students' scores on homework assignments, quizzes, and tests from the pre-intervention unit. Then, I focused on the students' scores during the post-intervention unit. I then discussed the student feedback from the surveys that were given prior to the study and at the end of the study.

Effects of Homework on Student Achievement

In this study, it was important to collect and compare various types of data to get an idea of how homework can affect student achievement. Looking at the data from the pre-intervention unit, we can analyze how having no option for correcting homework affects student achievement. Then, we can compare that data to the data from the post-intervention unit. This will help to answer the research question of how implementing a homework correction plan can effect student achievement.

In figure 1, the percent of homework assignments that students completed prior to taking their pre-intervention quiz was compared to the score they earned on that quiz. The mean percent of homework assignments completed was 78% with a standard deviation of 23.8. The standard deviation shows that the data is spread out with one student completing only 37.5% of their homework while numerous students completed 100% of their homework. The mean score for the pre-intervention quiz was an 85% with a standard deviation of 15.9. Again, the data values were spread out with the lowest score being a 46% and the highest score being a 100%. Therefore, the median of 89% can be used to account for the outliers in the data set. The correlation between the two variables was .28 which is quite weak.

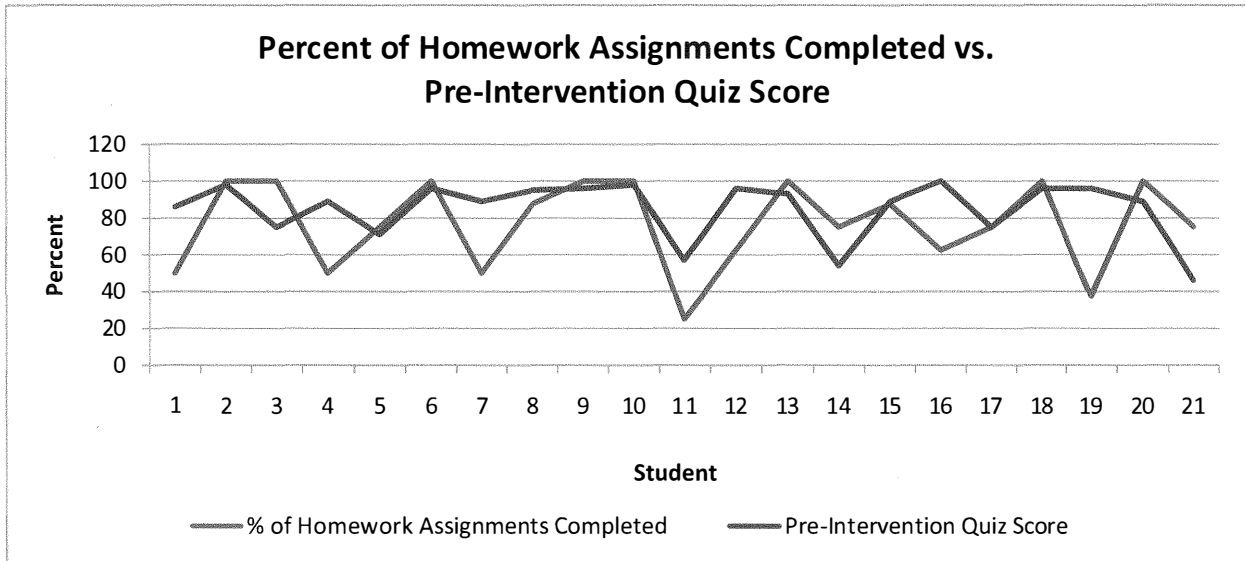

Figure 1.

In figure 2, the percent of homework assignments that students completed prior to taking their post-intervention quiz was compared to the score they earned on that quiz. The mean percent of homework assignments completed was 85% (median was 100%) with a standard deviation of 26.2. The standard deviation shows that the data is spread out with one student completing only 29% of their homework while numerous students completed 100% of their homework. The mean score for the post-intervention quiz was a 77% with a standard deviation of 17.5. Again, the data values were spread out with the lowest score being a 32% and the highest score being a 100%. The median of 84% takes the outliers into consideration. The correlation between the two variables was .06 which is extremely weak and shows almost no correlation.

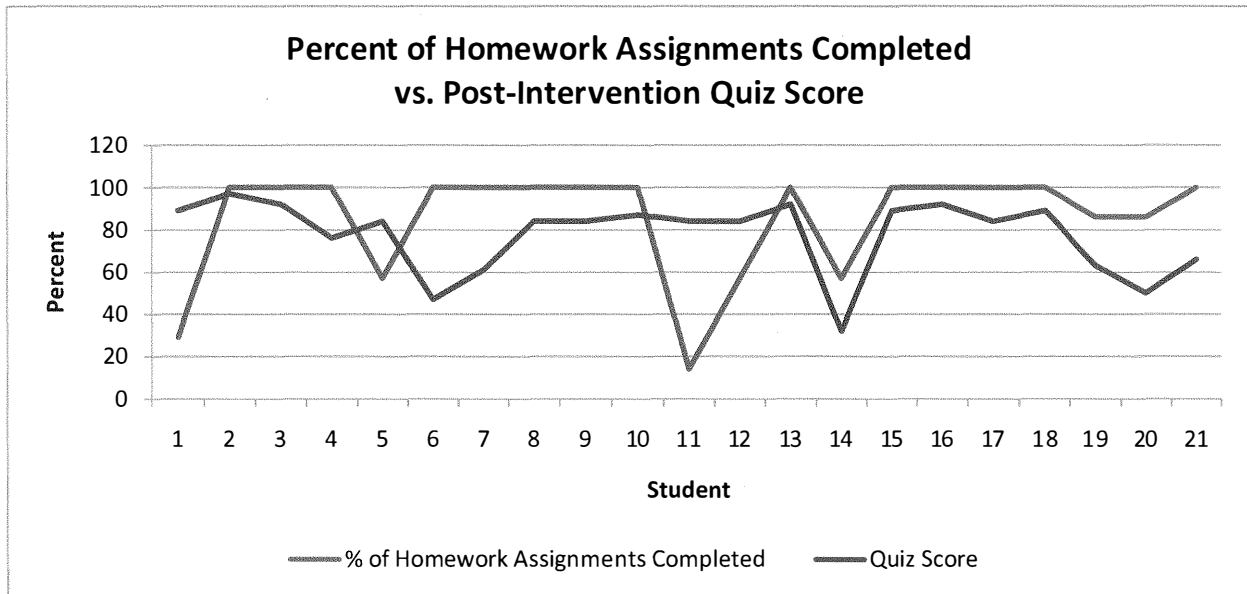

Figure 2.

Next, figure 3 compares how each student scored on both the pre-intervention and post-intervention quizzes. As mentioned earlier, the mean score for the pre and post-intervention quizzes were 85% and 77%, respectively. To account for outliers in the data, the median was also calculated as 89% for the pre-intervention quiz and 84% for the post-intervention quiz. The correlation of scores was .32 which is still fairly weak, but shows the strongest correlation yet.

There were five students who chose not to make any corrections to their homework assignments prior to the quiz in the post-intervention unit. One of these students also earned the lowest score on the post-intervention quiz and the second-lowest score on the pre-intervention quiz.

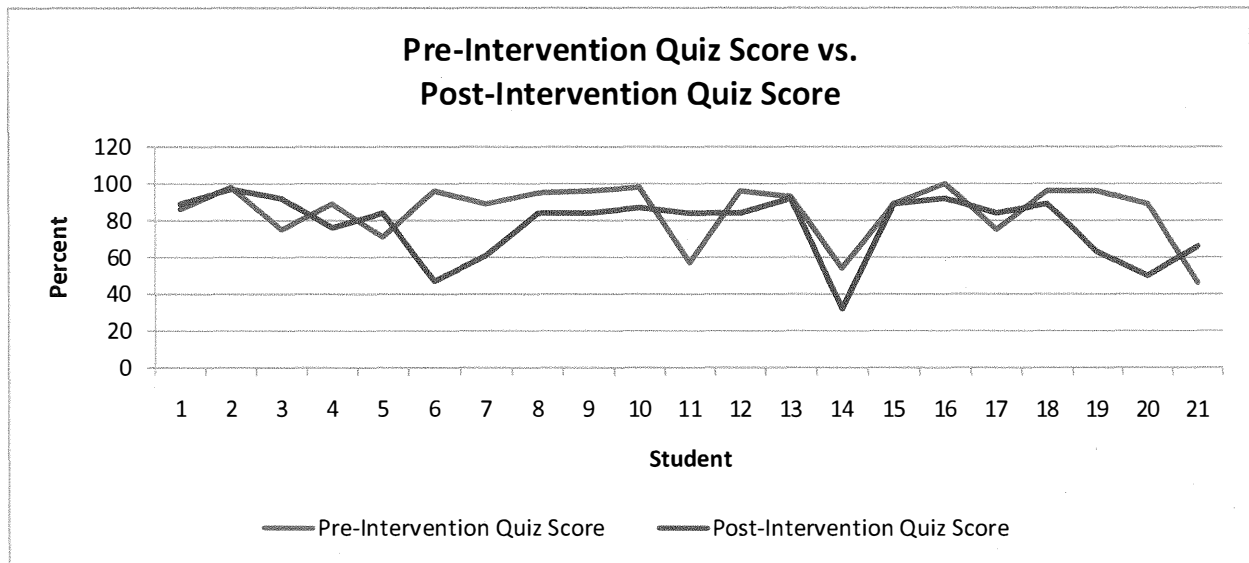

Figure 3.

The next set of data to analyze is the average homework scores of each student both before they made corrections and after. This will allow us to see which students chose to correct their homework and show how well they were able to correct their mistakes.

Each homework assignment was graded on a five-point scale where a score of five represented mastery of the content. In figure 4, students' grades are shown on the five-point scale. The mean score for homework before corrections were made was a 3.1 (out of 5) with a median of 3.4 and a standard deviation of 3.1. The mean score for homework after corrections were made was a 3.3 (out of 5) with a median of 3.6 and a standard deviation of 1.3. The correlation between these two variables was .97 which is a very strong relationship.

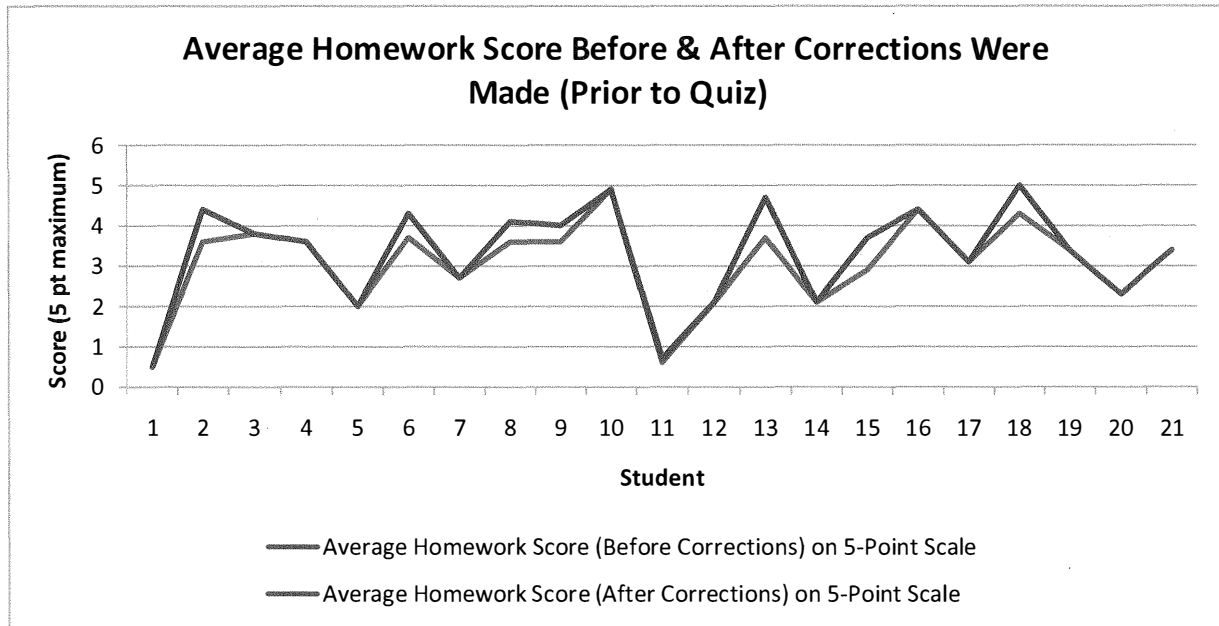

Figure 4.

The next set of data that was important to analyze was each students' average homework score after corrections were made compared to their post-intervention quiz score. In figure 5, the average homework scores, normally out of five points, have been converted to a percent so that we can easily compare them to the quiz scores. The mean score for homework was a 66% with a median of 72% and a standard deviation of 25.7. The mean score for the quiz as mentioned before was a 77% with a median of 84% and a standard deviation of 17.5. The correlation between these two scores was 0.2.

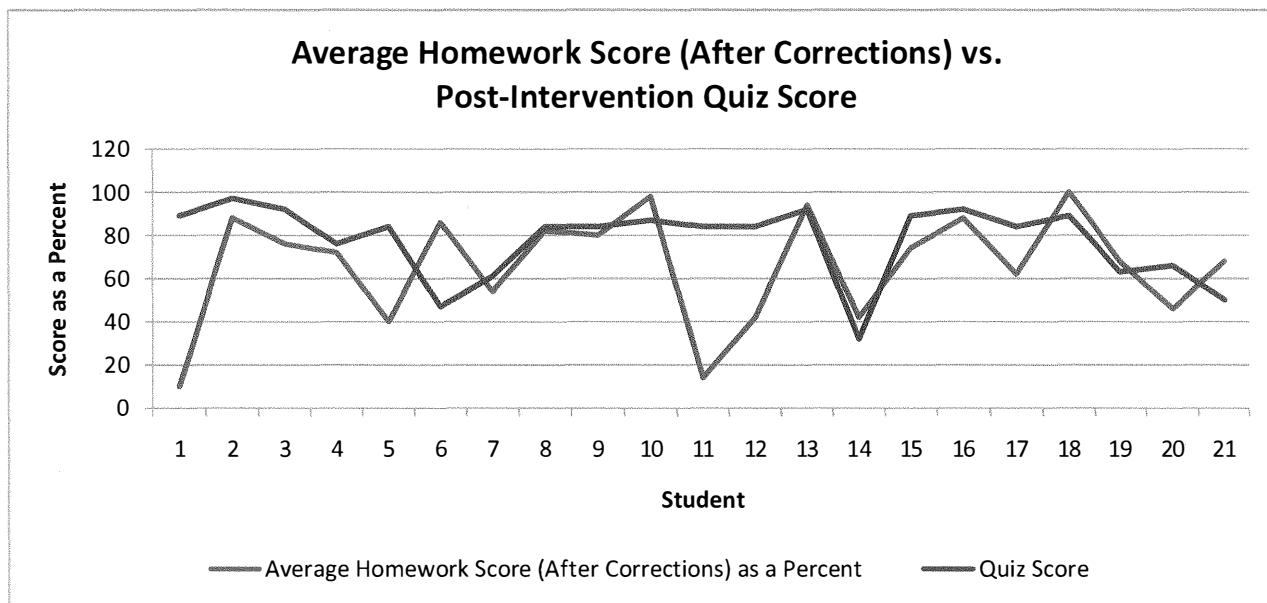

Figure 5.

Similar analyses were completed for the pre and post-test scores and homework scores leading up to those tests. It will be important to note the difference in scores from the prior analyses because the students have now seen the effect that their actions have had on their achievement. It will be insightful to see if they increase their homework corrections and/or test scores both from the prior unit and from their post-quiz score.

Figure 6 compares the percent of homework assignments completed and pre-intervention test score. The average percent of homework assignments completed was 86% which was an increase from the homework assignments completed leading up to the pre-intervention quiz. The median was 100% and the standard deviation was 20.5. The mean pre-intervention test score was a 78% and the median was an 83%. There was a standard deviation of 17.1. These scores were extremely close to the mean and median of the pre-intervention quiz. The correlation between these variables was 0.28.

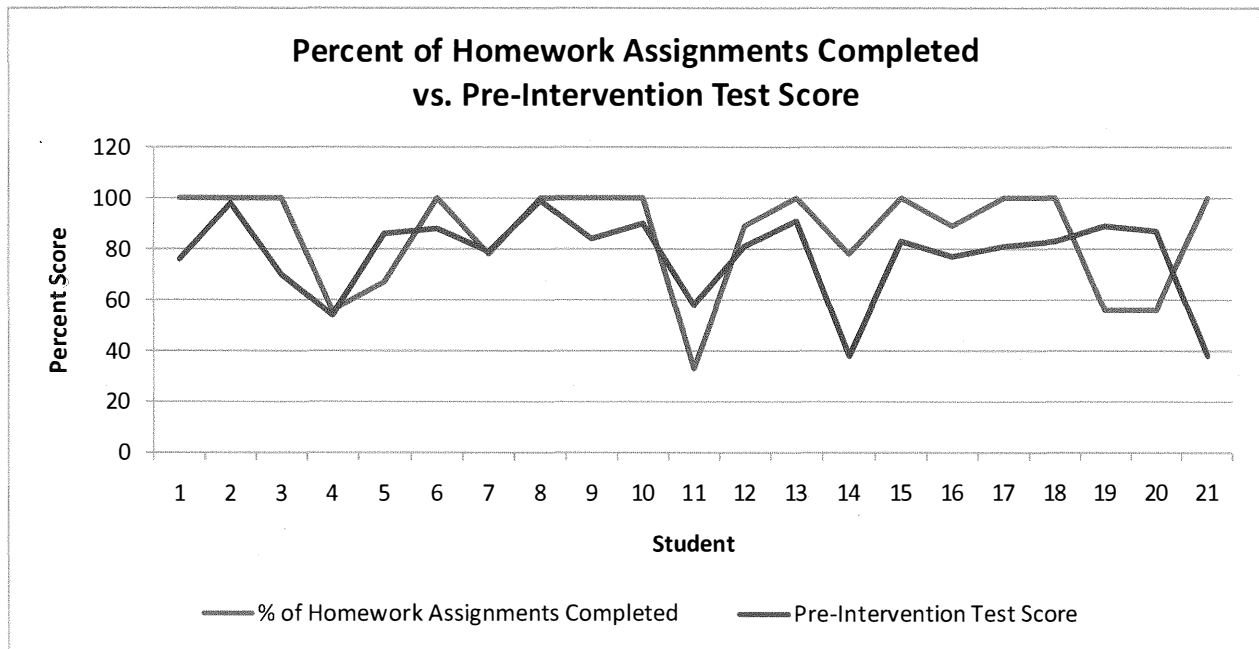

Figure 6.

In figure 7, the percent of homework assignments that students completed prior to taking their post-intervention test was compared to the score they earned on that test. The mean percent of homework assignments completed was 70% (median was 75%) with a standard deviation of 27.2. The standard deviation shows that the data is spread out with one student completing 0% of their homework while some students completed 100% of their homework. The mean score for the post-intervention test was a 75% with a standard deviation of 15.6. Again, the data values were spread out with the lowest score being a 35% and the highest score being a 97%. The correlation between the two variables was 0.4.

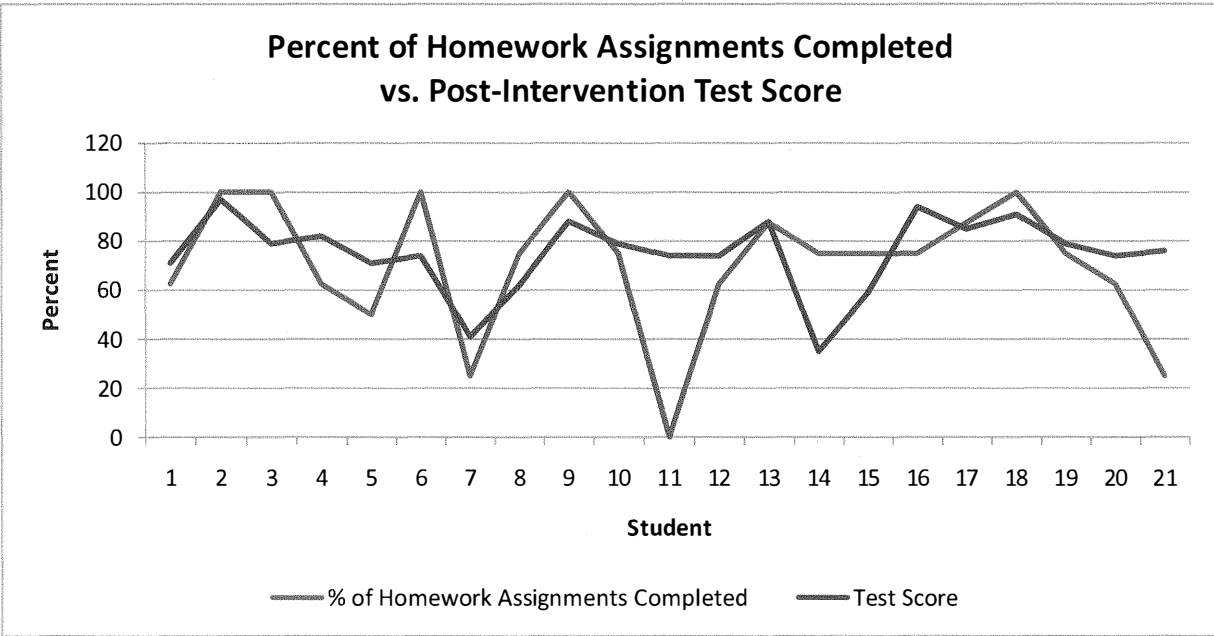

Figure 7.

Next, figure 8 compares how each student scored on both the pre-intervention and post-intervention tests. As mentioned earlier, the mean score for the pre and post-intervention tests were 78% and 75%, respectively. To account for outliers in the data, the median was also calculated as 83% for the pre-intervention test and 76% for the post-intervention test. The correlation of scores was 0.34.

There were five students who chose not to make any corrections to their homework assignments prior to the test in the post-intervention unit. One of these students also earned the lowest score on the post-intervention test and the lowest score on the pre-intervention test.

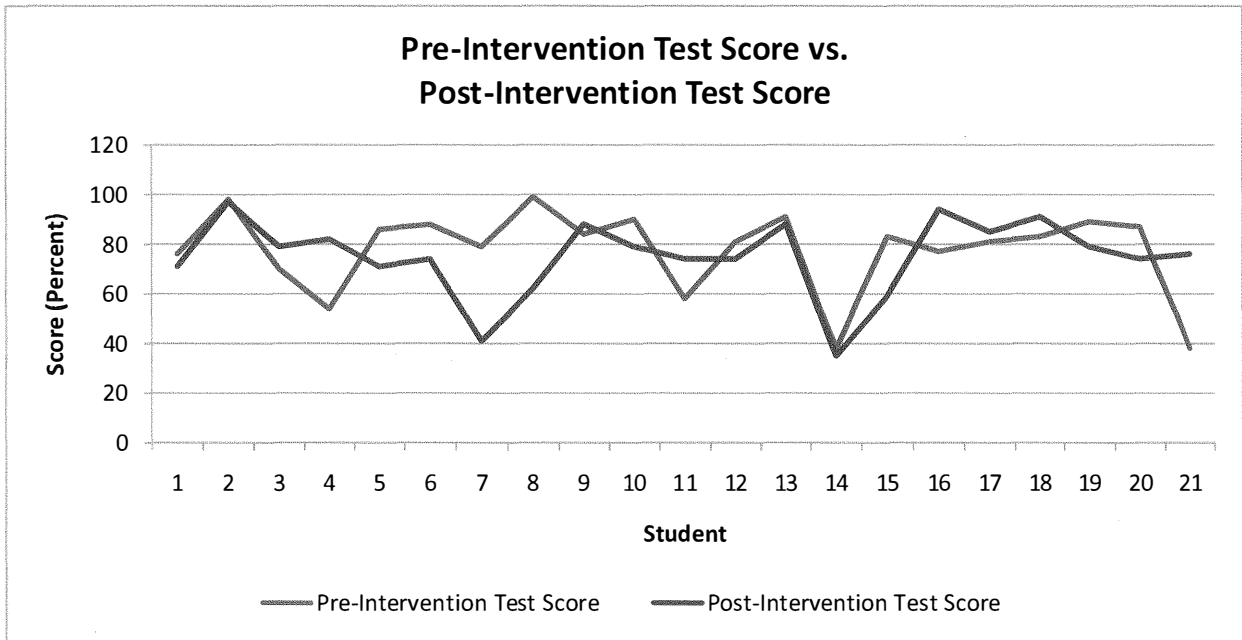

Figure 8.

The next set of data is the average homework scores of each student both before they made corrections and after. This will allow us to see which students chose to correct their homework and show how well they were able to correct their mistakes.

As explained before, each homework assignment was graded on a five-point scale where a score of five represented mastery of the content. In figure 9, students' grades are shown on the five-point scale. The mean score for homework before corrections were made was a 2.4 (out of 5) with a median of 3 and a standard deviation of 1.4. The mean score for homework after corrections were made was a 2.8 (out of 5) with a median of 3 and a standard deviation of 1.3. The correlation between these two variables was .92 which is a very strong correlation.

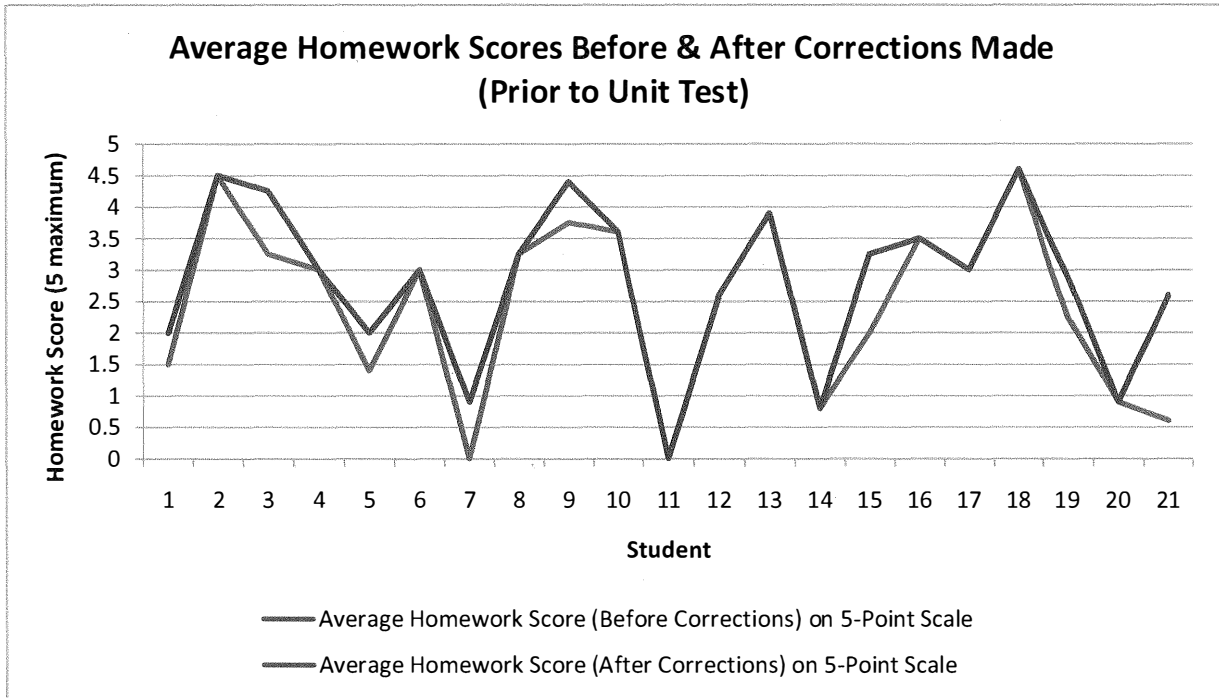

Figure 9.

The next set of data shows each students' average homework score after corrections were made with their post-intervention test score. In figure 10, the average homework scores, normally out of five points, have been converted to a percent so that we can easily compare them to the test scores. The mean score for homework was a 56% with a median of 60% and a standard deviation of 26.1. The mean score for the test as mentioned before was a 75% with a median of 76% and a standard deviation of 15.6. The correlation between these two scores was 0.66.

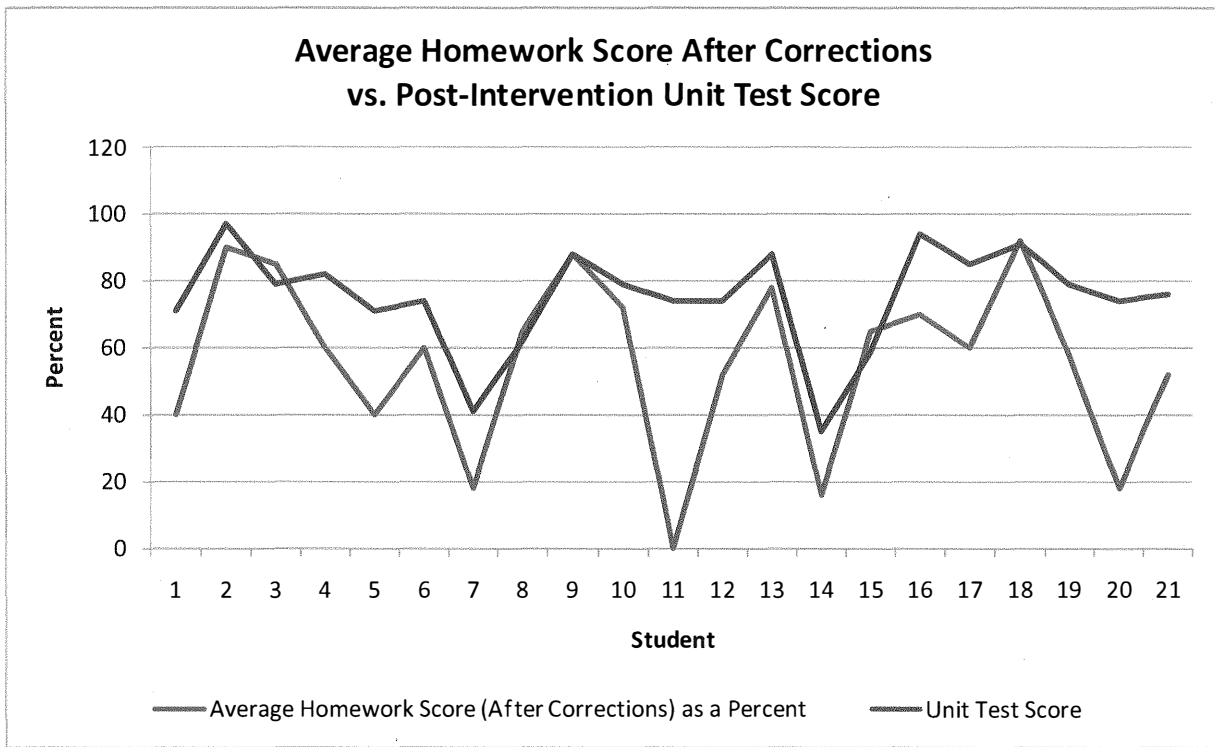

Figure 10.

The final data to analyze include the post-intervention quiz score and post-intervention test score. Figure 11 compares each student's quiz and test score from the post-intervention unit. As mentioned earlier, the mean for the post-intervention quiz was a 77% with a median of 84% and a standard deviation of 17.5. The mean for the post-intervention test score was a 75% with a median of 76% and a standard deviation of 15.6. The correlation between these two scores was 0.6.

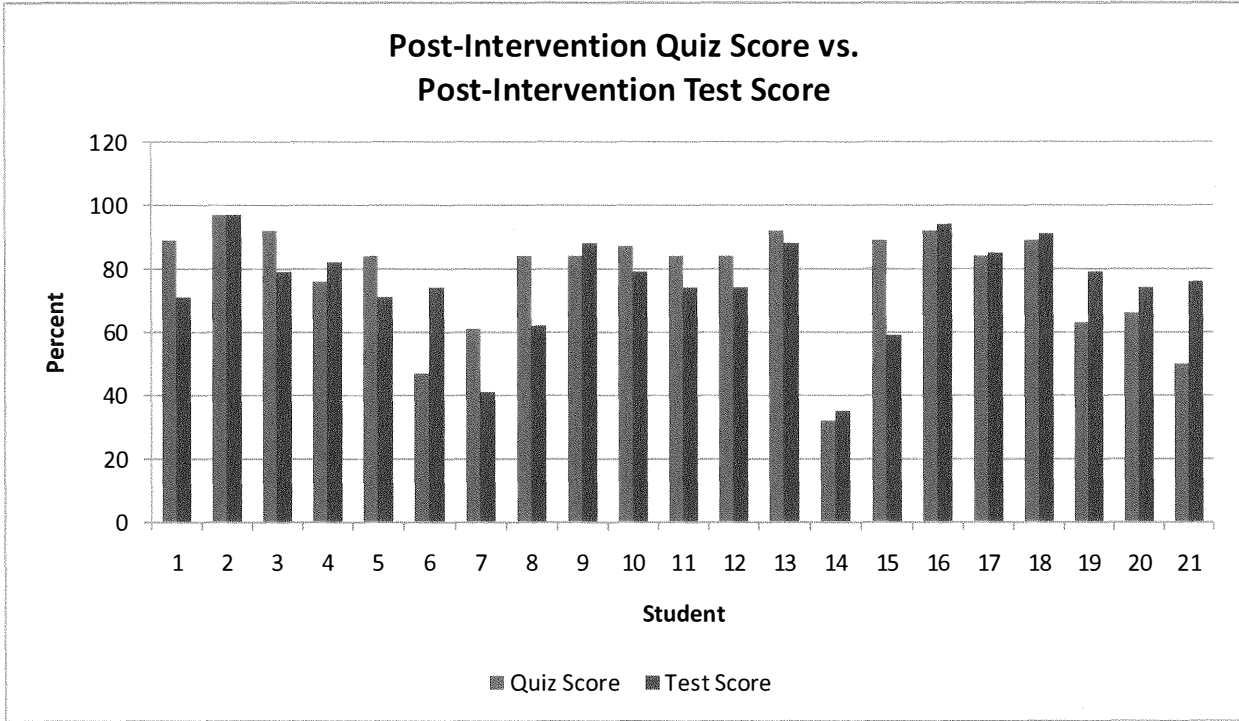

Figure 11.

Student Feedback from Pre-Survey

In addition to analyzing the data from the students’ homework, quiz, and test scores, it is important to look at their attitudes toward completing and correcting homework. We can then compare their attitudes to their scores. To analyze the data from the pre-survey and post-survey, I will first analyze the students’ responses to each question.

In figure 12, 70% or 14 out of 20 students, felt that students should receive homework in math. One student’s response was not counted in this data because they circled both yes and no.

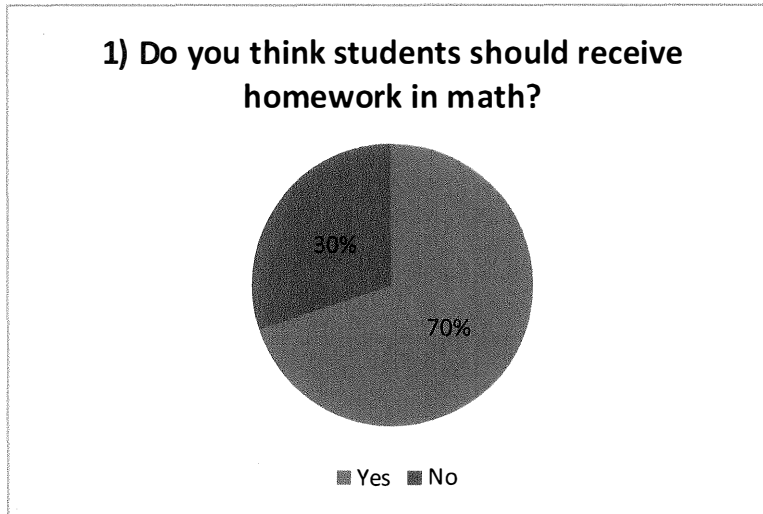

Figure 12.

The second question on the pre-survey allowed students to choose more than one response. In fact, they were asked to check all that apply. In figure 13, the bar graph shows which responses were checked the most. The reason most students did homework was because it helped them learn (71%). In contrast, no students felt homework was interesting. Many students felt that homework helped them improve their study skills (67%) and gave them a chance to work on their own (57%).

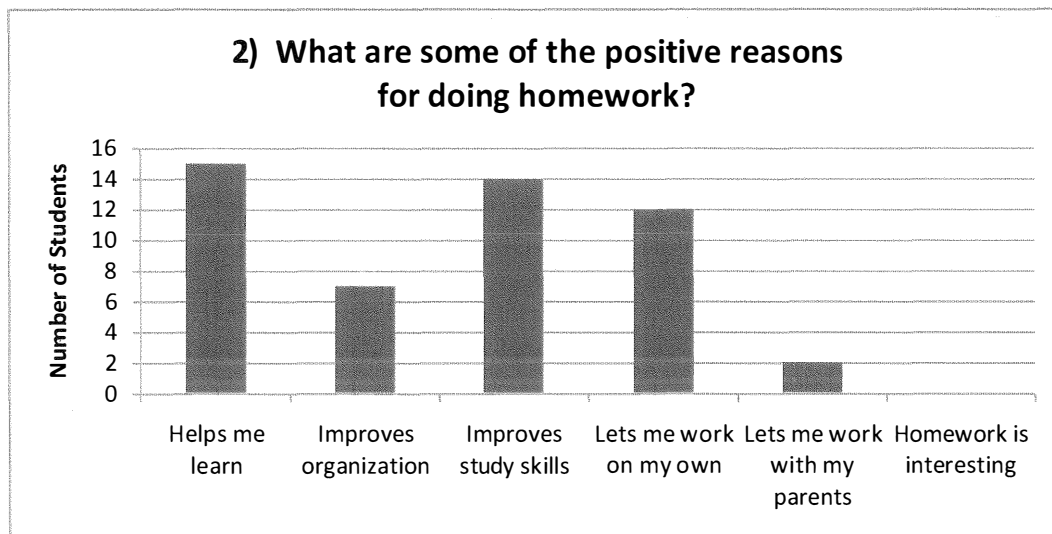

Figure 13.

In the next question, students were asked to choose one answer about how often homework should be given. Figure 14 shows that 62% (13 out of 21) of students think homework should be given every other day. Only one student felt homework should be given every day and one student felt it should never be given.

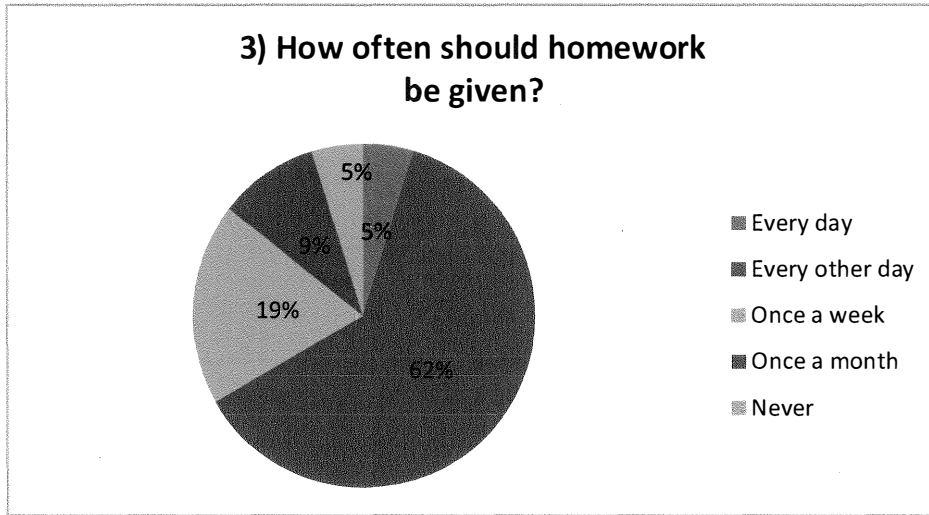

Figure 14.

In question four, students were asked how long they think they should spend on their math homework each night. They were only allowed to choose one answer. Figure 15 shows the students' responses to this question. Most students, 43% or 9 out of 21, thought 15 minutes was a good amount of time to spend on their math homework. No students responded that they should be spending an hour on their math homework.

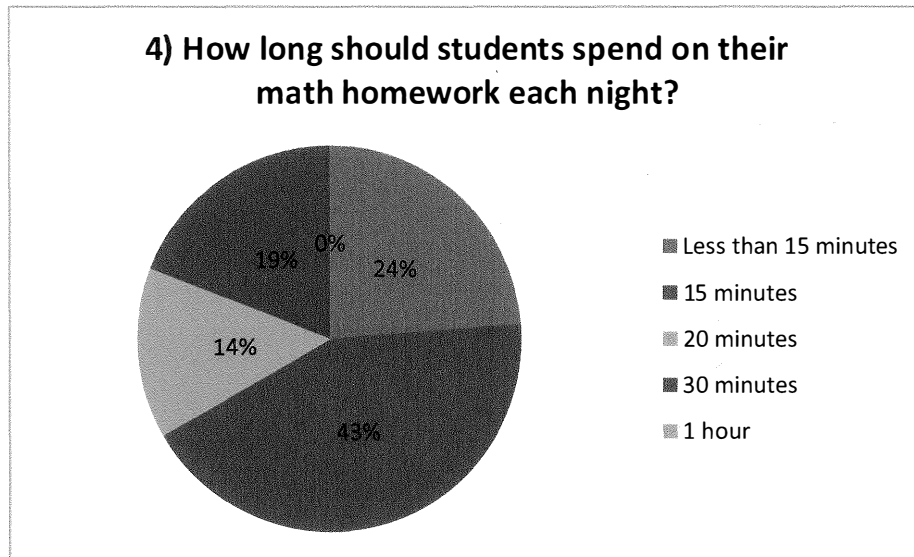

Figure 15.

The fifth question of the pre-survey asked students to use a Likert-scale to describe how important they felt it was to complete their homework. A response of one meant that it was not important, two meant it was slightly unimportant, three was a neutral response, four meant it was important and a score of five meant it was very important. The bar graph in figure 16 shows the students' responses to this question. The most common response (48%) was a four, meaning students felt it was important to complete their homework. In addition, 38% of students felt completing their homework was very important. There were no students that responded that homework was not important.

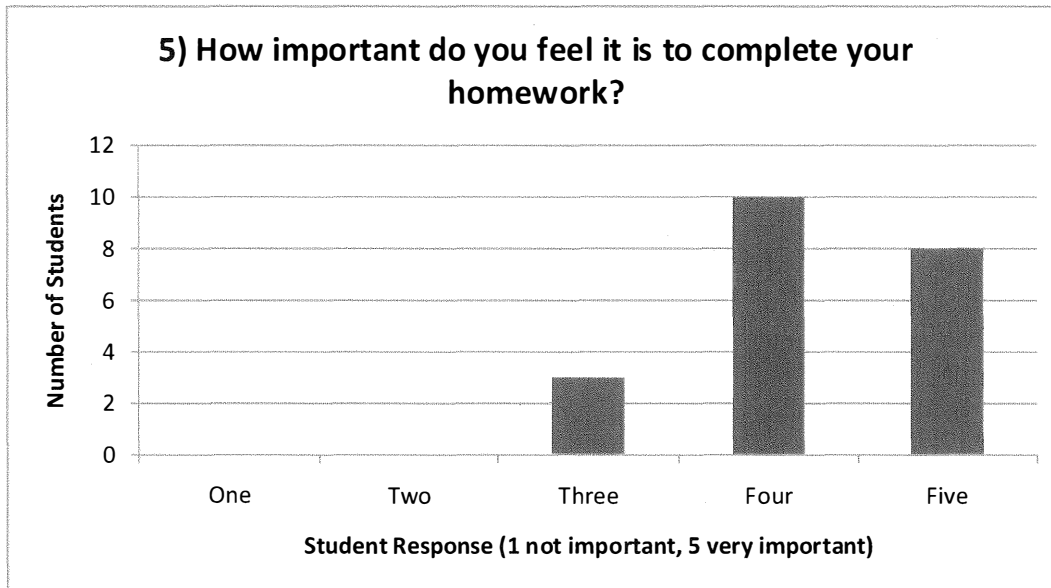

Figure 16.

Similar to question five, the following question asked students to rate how important they felt it was to complete their homework correctly. Again, they were given a Likert-scale where a response of one meant it was not important and a response of five meant it was very important.

Figure 17 shows the student's responses to this question. Eight out of 21 students, or 38% of the class, felt that it was very important to complete their homework correctly. Seven students, 33%, felt that it was important to complete their homework correctly. There were no students who felt it was not important to complete their homework correctly. However, there was one student who felt it was slightly unimportant.

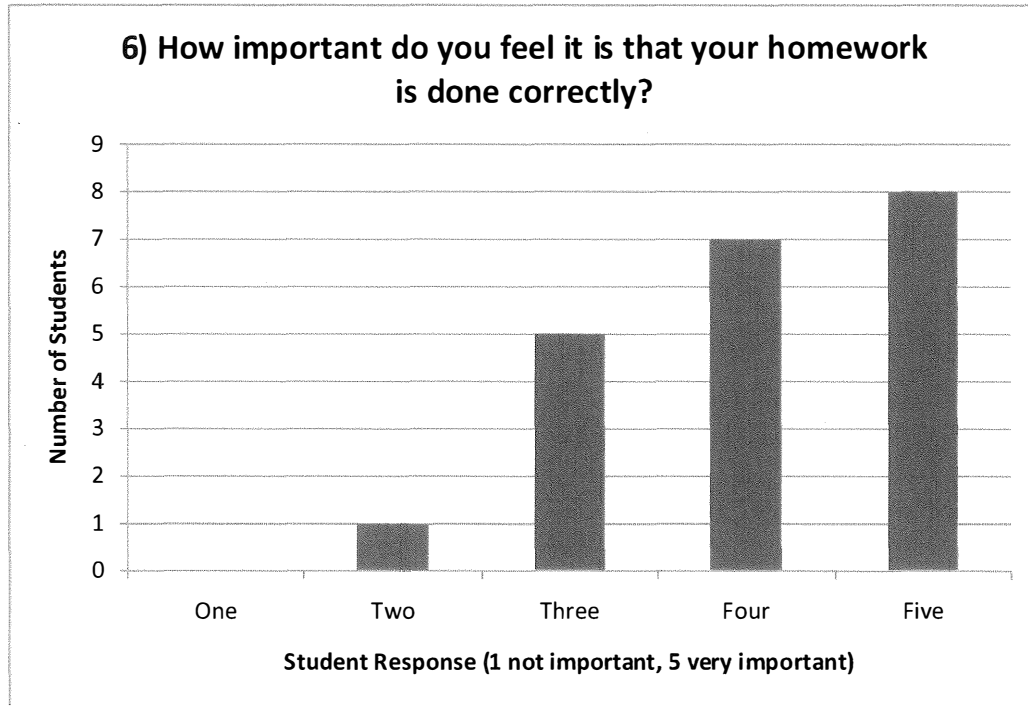

Figure 17.

The last Likert-scale question on the pre-survey asked students how important they felt it was to fix the mistakes they made on their homework. As before, a response of one meant that students felt it was not important and a score of five meant that students felt it was very important.

Figure 18 shows that most students responded with a three or four. Therefore, most students felt it was slightly important to fix their mistakes. There were not any students who felt it was not important.

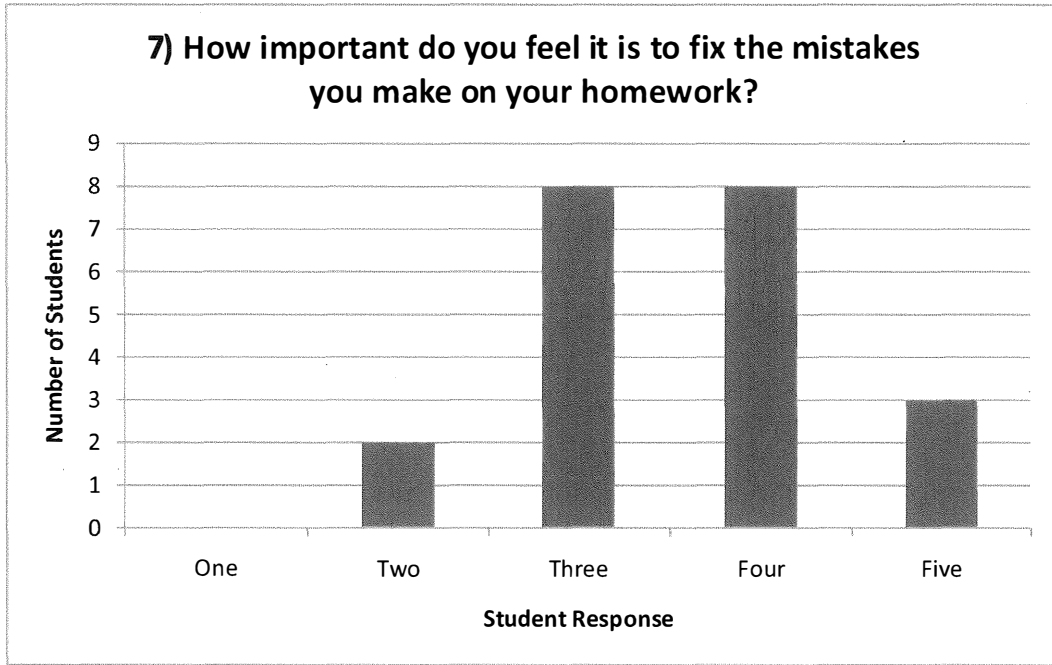

Figure 18.

Students were asked whether they felt they were more likely to do well on their tests if they did well on their homework. The majority of students, 14 out of 21, felt there was a relationship. Figure 19 shows that most students in the class believed this to be true.

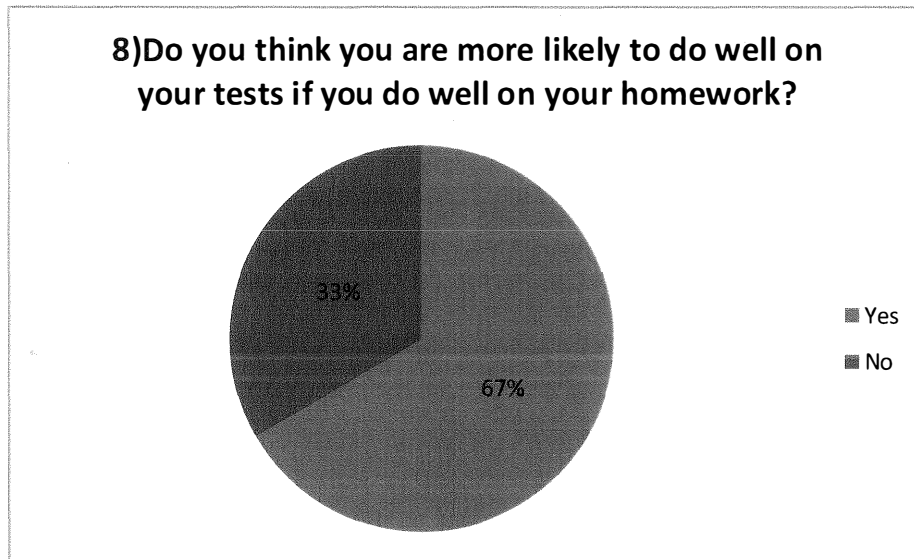

Figure 19.

The last two questions of the pre-survey asked students to respond to a “yes/no” question as well as provide a written response to explain their choice. The first question asked students if they thought the grades on their homework were related to the grades on their tests. The class was almost completely split in half with their opinions. Eleven students responded “yes” and ten students responded “no.” Figure 20 shows some of the students’ responses to the written portion of the question.

Do you think the grades on your homework are related to the grades on your tests?

Sample responses of “yes”	Sample responses of “no”
Homework prepares us for the test.	It is possible to do well on homework, but miss questions on the test.
You study by practicing on homework.	Some students might copy their friend’s homework.
Homework gives you more practice.	I work better under pressure.
The test is basically your homework combined.	The time limit on tests can make you make mistakes.
The test has the same type of questions as the homework.	I breeze by my homework because I know how to do it.
You might make the same mistakes on the test as your homework.	I get A’s on my tests and don’t do my homework.
I just think they are related.	Tests are more pressure.

Figure 20.

The final question on the pre-survey asked students if they thought fixing the mistakes on their homework would help them do better on their tests. Seventeen out of 21 students, 81% of the class, responded “yes.” There were only four students who did not think there was a relationship. Figure 21 shows some of the students’ responses to the written part of this question.

Do you think fixing the mistakes on your homework will help you do better on your tests?

Sample responses of “yes”	Sample responses of “no”
It will help you understand and do good on the test.	I only need to look at it. I don’t need to correct it.
I won’t make the same mistakes on the test.	I can fix it in my head. I don’t need to write it down.
It will help you remember for the test.	
You can learn from your mistakes.	
Your mistake isn’t corrected if you are practicing the wrong stuff.	
It helps you acknowledge that you made a mistake.	
It helps me remember for the test.	
When you try again you can learn to do it right.	
You can learn from your mistakes or learn the incorrect way if you don’t.	
You might use your homework to study for the test.	
You can find your mistakes and improve.	
You can fix your mistakes and know what you did wrong.	
You need to correct yourself so your brain remembers.	

Figure 21.

Student Feedback from Post-Survey

At the end of the post-intervention unit, students were given a post-survey. The survey consisted of six questions, three of which were Likert-scale questions, one yes/no question, and two questions that required a written response. The questions were very similar to the questions on the pre-survey, but were meant to make students think about the homework correction policy that was just implemented. Similar to the previous section, the students’ responses were analyzed and displayed in charts and graphs for easy interpretation.

The first question of the post-survey asked students how important they felt it was to complete their homework. This was the same as question five from the pre-survey. In figure 22,

we can see similar results to the pre-survey responses. There were no students who thought homework was not important. The majority of students, 11 out of 21, felt it was very important. In fact, 95% of the class felt that homework was important or very important to complete.

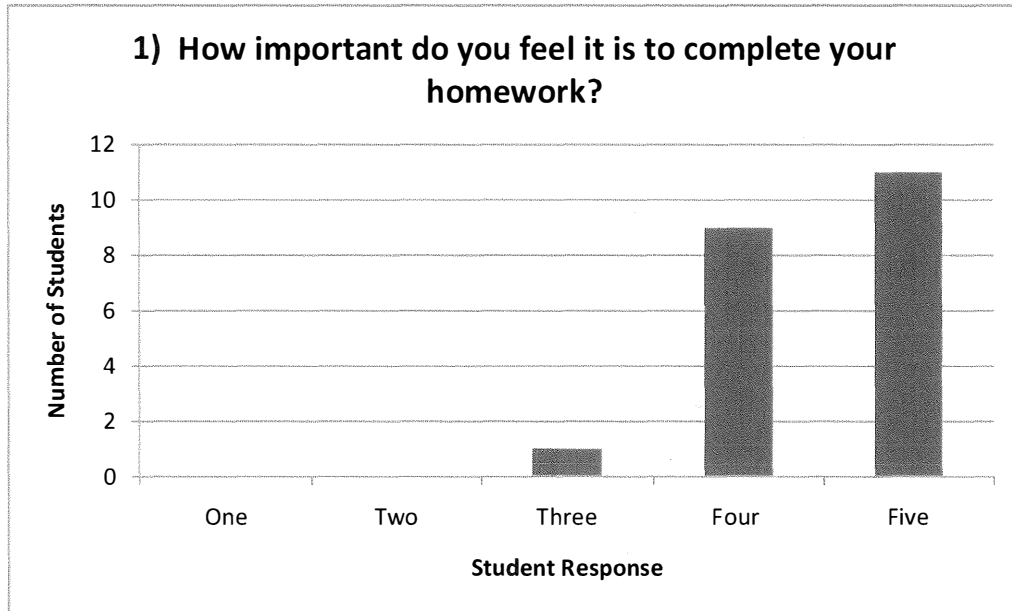

Figure 22.

The second question of the post-survey was the same as question six from the pre-survey. It asked students to rate how important they felt it was to complete their homework correctly. A score of one meant it was not important and a score of five meant it was very important. The results show that students felt it was more important during the post-survey. In figure 23, we can see that 18 out of 21 students, or 86%, felt it was important or very important to complete their homework correctly. There were three students who felt neutral about the importance, but none that felt it was unimportant.

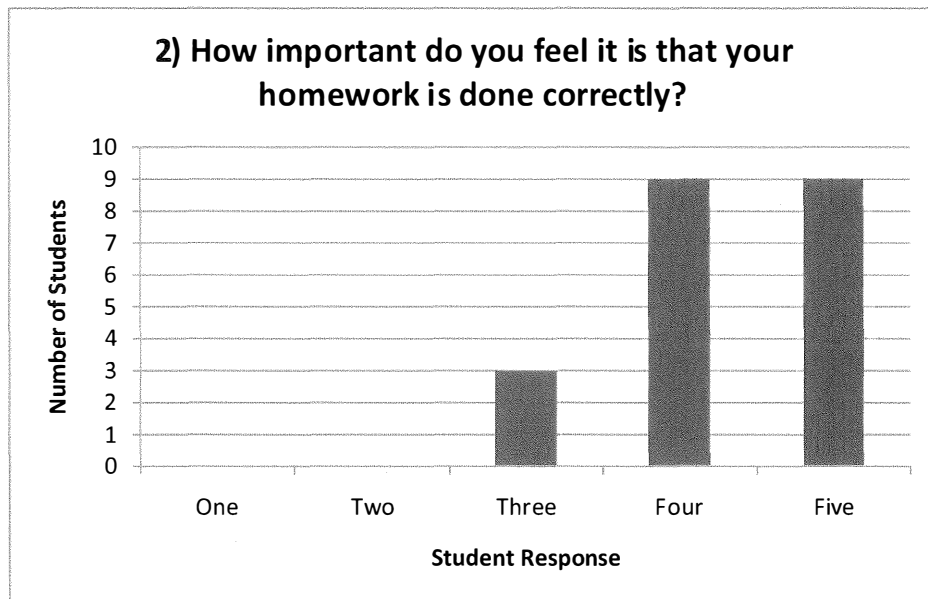

Figure 23.

The next question on the post-survey asked students to rate how important they felt it was to fix the mistakes they made on their homework. This was the same as question seven on the pre-survey. The student responses from this question can be seen in figure 24. The majority of the class, 11 out of 21 students or 52%, felt that it was very important to fix the mistakes on their homework. There were only three students who felt this way on the pre-survey. It may be that the students who thought fixing their homework was important, a response of four, now felt that it was very important. There were zero students who thought it was not important which is the same as the pre-survey responses.

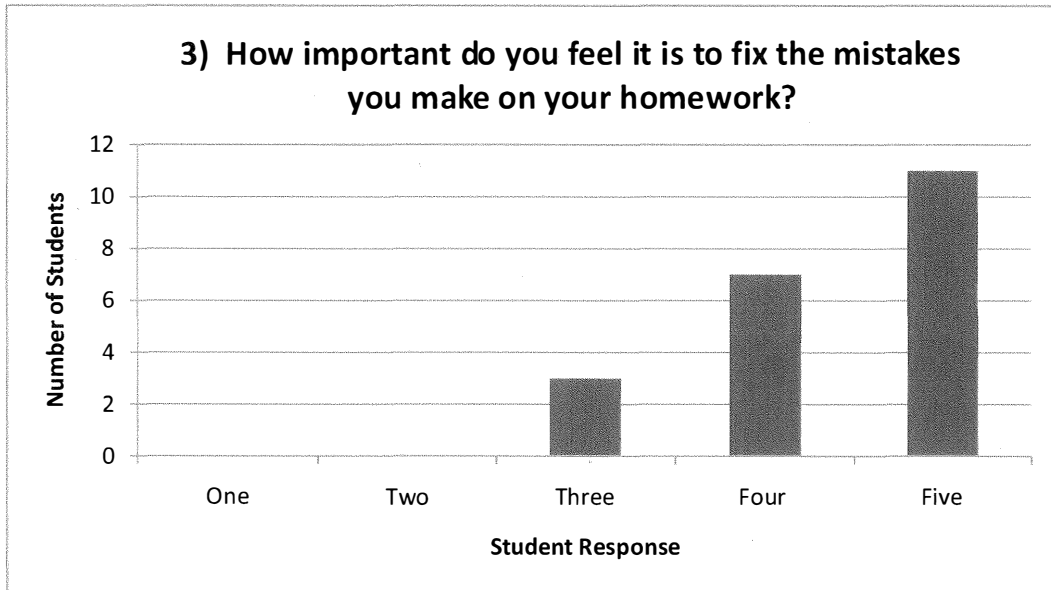

Figure 24.

The fourth question of the post-survey was a yes or no response question where students were asked if they felt they were more likely to do well on their tests if they did well on their homework. In question eight of the pre-survey, 67% of students responded that there was a relationship. In the post-survey, 86%, or 18 out of 21 students agreed that they are more likely to succeed on tests if they did well on homework. Figure 25 shows how the class responded to this question.

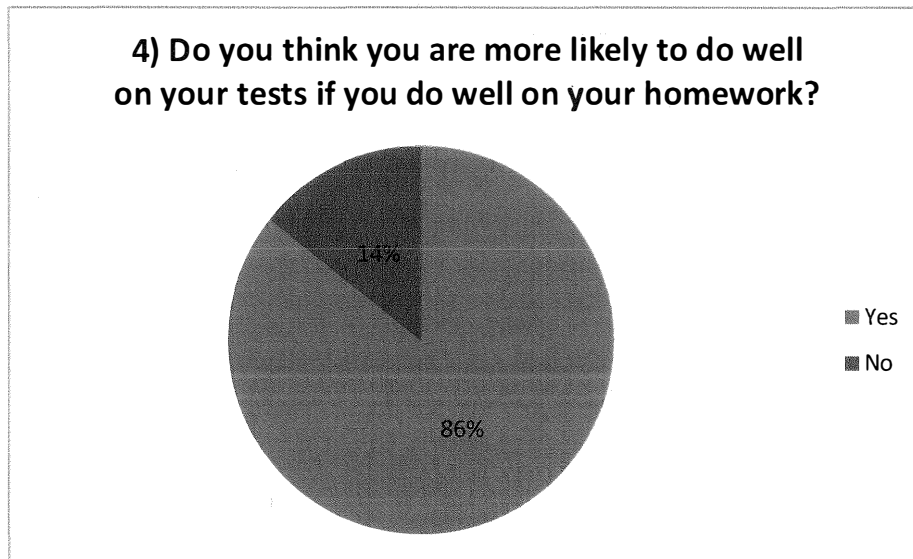

Figure 25.

The next question on the post-survey was a yes/no question followed by a written response. It asked students if they felt their grades on their homework were related to their grades on their test. This corresponds to question nine on the pre-survey. There were 15 students out of 21, or 71%, who felt their homework grades were related to their test grades. Figure 26 shows some of the student responses from this question on the post-survey.

Do you think the grades on your homework are related to the grades on your tests?

Sample responses of “yes”	Sample responses of “no”
Homework is like a practice test to tell you what to study.	I can do better on my test even if I don’t do good on my homework.
Usually you do the same on your homework and tests.	Tests are always harder because you have to remember a lot.
If you do bad on your homework, you might do bad on your test.	
If you don’t understand a question on your homework, you won’t understand it on your test unless you get help.	

Figure 26.

The last question of the post-survey asked students if they felt fixing the mistakes on their homework helped them do better on their test. It also asked students to provide a written response to explain their choice. This was similar to question ten on the pre-survey where 81% of students felt that fixing their mistakes would help them do better on their tests. There were 17 students who felt there was a relationship, while four said they did not think fixing their homework helped them do better on their test. These results are exactly the same as the pre-survey. However, their written responses differed slightly. Figure 27 shows some of the students’ responses to this question.

Do you think fixing the mistakes on your homework helped you do better on your tests?

Sample responses of “yes”	Sample responses of “no”
I learned how to do problems I didn’t understand.	I didn’t fix my mistakes and I did good on my test.
I found out my mistakes so I didn’t do the same thing on my test.	There weren’t any mistakes I had to correct.
It helped me remember for the test.	I can just fix them in my head.
I could use my homework to study.	
I could practice the problems I got wrong.	

Figure 27.

There are numerous conclusions and interpretations that can be made from the data that resulted from the student homework grades, quiz and test scores and opinions on the pre and post-surveys. Looking at these results separately as well as a whole provides us with insights into the research question of how homework can affect student achievement. In addition, and more specifically, how implementing a homework correction plan can effect student achievement.

Chapter Five: Discussions and Conclusions

The purpose of this study was to investigate how homework effects student achievement and more specifically, how implementing a homework correction plan effects student achievement. There are many conclusions that can be made from the results of this study. It is important to discuss and compare the results from the pre-intervention and post-intervention scores as well as the pre-survey and post-survey responses. In addition, limitations of the study, implications for practice, and focus for future research are important topics to discuss.

Completed Homework Assignments

When students are assigned a homework assignment, they make a choice to complete that assignment based on whether they feel it is important to them. They may feel it is important to them because of their grade, what their teacher or parents will think, or their interest in the topic. There are numerous reasons for why a student may choose to complete their homework or not.

One of the first findings from this study is that students completed more homework assignments prior to the quiz in the post-intervention unit, but fewer homework assignments prior to the test in the post-intervention unit. In the pre-intervention unit, the average percent of homework completed prior to the quiz was 78% and for the post-intervention unit it was 85%. In the pre-intervention unit, the average percent of homework completed prior to the test was 86% and for the post-intervention unit was 70%. It is interesting to note that the pre-survey showed that 48% of the class felt completing homework was important and 38% of the class felt it was very important. The post-survey showed that 43% of the class felt completing homework was important, but 52% felt it was very important.

Perhaps there is a decrease in the post-intervention unit homework average because it was the last unit of the school year and students were feeling stressed or overloaded with other

work. On the other hand, they may have felt confident in their understanding based on their quiz score and didn't feel the need to complete as many homework assignments. According to the post-survey results, most students felt completing homework was very important and perhaps wished that would have completed more to do better on their assessments. Whatever the reason for lack of homework completion, their scores reveal that there is some relationship between homework and achievement.

Assessment Scores vs. Completed Homework Assignments

The main focus of this study was how homework can effect student achievement and by looking at the results of the assessments given, we can see there is some relationship between these two variables.

As stated earlier, the average percent of homework completed prior to the pre-intervention quiz was 78% and prior to the post-intervention quiz was 85%. Seeing that more students chose to complete their homework in the post-intervention unit, we should see an increase in their quiz scores. However, the opposite occurred. Although the scores were very close when we compare the median score rather than the mean score, we need to consider why this occurred. The median score for the pre-intervention quiz was 89% (85% mean) and for the post-intervention quiz was 84% (77% mean).

There are many possibilities for why the post-intervention scores were not higher. It could have been that the two quizzes were not similar in difficulty level. Perhaps the concepts on the post-intervention quiz were more difficult for students to grasp. There are always outside factors to consider as well. For example, students may have had other assessments that day or projects that they needed to prepare for. It is difficult to find one specific reason because there are so many factors that could influence their performance on that day.

We also need to compare the results from the tests that were given. As stated earlier, the average percent of homework completed prior to the pre-intervention test was 86% and prior to the post-intervention test was 70%. Seeing that fewer students chose to complete their homework prior to the post-intervention test, we should see a decrease in their test scores. The scores were very close when we compare the mean score rather than the median score. The median score for the pre-intervention test was 83% (78% mean) and for the post-intervention test was 76% (75% mean).

Although the purpose of the study was to see a positive correlation, meaning if students complete their homework they should do well on assessments, the results show that when students did not complete their homework they did not do as well on their assessments. Prior to the post-intervention test, students completed 16% less homework assignments and ended up scoring 7% (using the median) lower on the test. If they had completed all their homework, the test average may have been much higher. However, using the results from the study, we can see that not completing homework can negatively affect student achievement.

Assessment Scores vs. Homework Scores

Another purpose of this study was to investigate how implementing a homework correction plan would affect student achievement. Giving students the option to correct the mistakes on their homework gives them additional practice and can resolve misconceptions or misunderstandings about the content. When students were asked on the pre-survey how important they felt it was to correct the mistakes on their homework, they had a neutral opinion or felt that it was slightly important to fix the mistakes on their homework. However, when asked if they felt fixing mistakes on their homework would help them do better on their tests,

81% of the class responded with “yes.” There were a variety of explanations for their choice as can be seen in Figure 21.

The relationship that needs to be considered is the score on the post-intervention quiz and test to the average homework score after corrections were made. We would expect that these scores would be similar or that the assessment score would be higher than the homework score and that is what the results show.

The average homework score prior to the post-intervention quiz was 66% (72% median) and the average quiz score was 77% (84% median). The difference between the two averages was 11% (12% median) which is fairly close. The fact that the scores on the quiz were higher than the homework scores show that there is a relationship between completing and correcting homework to student achievement.

The average homework score prior to the post-intervention test was 56% (60% median) and the average test score was 75% (76% median). The difference between the two averages was 20% (16% median) which is larger than the previous difference, but still fairly close. These results also show a relationship between homework and student achievement because the students scored higher on their assessments than their homework.

Interestingly, on the post-survey, 52% of students felt that it was very important to fix the mistakes on their homework. This is quite a jump from the pre-survey where only 14% of students felt it was very important. The students may have learned from their test score that if they had taken the time to complete or correct more of their homework, they may have had a higher test score.

Student Opinions

The results from the study leave us with questions about why students choose not to complete or correct homework. Their responses to the survey questions may lead us to some answers or things to consider. For example, although 70% of students felt they should receive homework in math, mostly because it helps them learn, 62% of students wanted homework only every other day. During both units in this study, homework was given daily with the exception of a quiz or test day. This may have deterred students from completing or correcting their homework because they felt overwhelmed. If they had homework in their other classes, they may have felt it was too much for them to complete on a daily basis.

Similarly, 43% of students felt their math homework should take them 15 minutes to complete. Most of the homework assignments for this unit were designed to take 15 to 25 minutes to complete. For students who struggle in math, they may have been taking 25 minutes to complete the homework and did not feel like spending another 10 minutes to correct old homework. If students struggled in other subject areas besides math, they may have been spending hours each night on homework and did not want to do their homework at all.

Although students generally felt homework was important, there are many factors that influence their choice of whether to complete and/or correct their homework assignments nightly. These factors are beyond the scope of this study, but are certainly important to consider in future research.

Limitations of the Study

Although this study had important results, there were also some limitations. As in any study, there are a number of variables that can affect the intended outcome. This study was convenience-based, which means I was only able to include one class of 21 students to

participate. Normally, a larger sample is desired, but because of my position on a shared team, each class I taught was different and I would not be able to make comparisons in that way. It would have been helpful to have two of the same classes so that I could compare the effect homework had on each class. I would have been able to make generalizations based on the outcomes. With one class, there isn't anything to compare it against and so the conclusions made may differ in another similar study. Even better, would have been to use an entire grade level or school in the study.

A second limitation to the study was newness of the homework correction plan. Students had been accustomed to completing their homework all year without the opportunity to make corrections. Since this study was conducted toward the end of the school year, some students did not feel the need to invest their time in correcting homework. They may have been overwhelmed with the end of the year pressures such as final exams and projects. So, although they felt completing homework was important, they may not have put forth as much effort as usual.

Finally, the units that were included in the study may have been a limitation. Since not all units are equally difficult for students, the pre-intervention and post-intervention topics may have varied in difficulty level causing a difference in student achievement. Some students may have found that the homework in the second unit was more difficult and therefore chose not to complete all of it or correct it and scored lower on their assessments. This may be another reason to conduct the study with two separate classes where one class is the control group. This would ensure the content was exactly the same and the results would be more reliable.

Implications for Practice

Although there are limitations in this study, the results are important to educators. First, it is extremely important to be aware of students' feelings toward homework and its purpose. In this study, students felt they should be spending 15 minutes on their homework, while I expected them to be spending 15 to 25 minutes. If this expectation was clear at the start of the school year, students wouldn't be frustrated when their homework took longer than expected. In addition, it is important to explain to students why they are being given homework as often as they are. They should know what is expected of them in terms of correcting their homework to a level of mastery. If the students are aware of their teacher's motivations and expectations at the beginning of the year, students are likely to benefit from their homework.

Secondly, it is important for teachers to implement a plan at the beginning of the year so that students have time to get used to the expectations. In this study, the homework plan was introduced towards the end of the year and not all students bought into it immediately. Just as routines are established early on, expectations for homework should be established and practiced throughout the year.

The most important implication for practice is that teachers are made aware of the importance of homework. The research has shown that time spent outside of school on learning can effect student achievement. If they choose to include homework as part of their class, they need to be aware of pieces that play a role in helping the students be successful. Giving homework does not result in greater student achievement. Giving well-planned, purposeful, and engaging homework is more likely to affect student achievement in a positive way.

Future Research

In the field of education, specifically focusing on homework, there is a great need for future research. There are numerous variables that can be explored when studying the homework-achievement relationship. For example, researchers can look at the time spent on homework, the length of homework, how often homework is given, the purpose of homework, etc.

One area I would recommend for future research is how students who achieve mastery on their homework can increase their achievement. In this study, students were given the option to attain mastery. In future studies, teachers could require that students achieve mastery on their homework before being able to take an assessment. I think a study like this would be valuable because if students were able to perform a task on a homework assignment successfully, they should be able to perform a similar task successfully on an assessment.

Another avenue of future research is to study the values and beliefs students have towards homework and then apply those beliefs into a classroom to see if it increases their achievement. For example, if a class believes they should be given homework every other day rather than daily, implement a plan where that is the expectation and see if students benefit from it. Similarly, if students find homework disinteresting, implement homework that is family-oriented or involves student-created problems. If students feel homework is interesting, they may be more likely to complete it and benefit from it. There are several facets of homework that can be studied in the future to find what most affects student achievement.

Conclusion

Homework is a highly debated issue when it comes to student achievement and the education in our country. The number of variables that can be considered when studying the

homework-achievement relationship is overwhelming, but as more and more studies are conducted to help teachers make informed decisions about their practice, we get closer and closer to competing with our international counterparts. Although homework has been a topic of discussion among educators for decades, it is important to continue the discussions and find what methods are most influential to our students' achievement.

References

- Baines, L. (2007). Learning from the world: Achieving more by doing less. *Phi Delta Kappan*, 89, 98-100.
- Brock, C.H., Lapp, D., Flood, J., Fisher, D., & Han, K.T. (2007). Does homework matter? An investigation of teacher perceptions about homework practices for children from nondominant backgrounds. *Urban Education*, 42, 349-372. doi: 10.1177/0042085907304277
- Bryan, T. & Sullivan-Burstein, K. (1998). Teacher-selected strategies for improving homework completion. *Remedial and Special Education*, 19, 263-275.
- Cooper, H. (1989). Synthesis of research on homework. *Educational Leadership*, 47, 85-91.
- Cooper, H., Lindsay, J.J., Nye, B., & Greathouse, S. (1998). Relationships among attitudes about homework, amount of homework assigned and completed, and student achievement. *Journal of Educational Psychology*, 90, 70-83.
- Cooper, H., Valentine, J.C., Nye, B., & Lindsay, J.J. (1999). Relationships between five after-school activities and academic achievement. *Journal of Educational Psychology*, 91, 369-378.
- Cooper, H. & Valentine, J. C. (2001). Using research to answer practical questions about homework. *Educational Psychologist*, 36, 143-153.
- Cooper, H., Robinson, J.C., & Patall, E. (2006). Does homework improve academic achievement? A synthesis of research, 1987-2003. *Review of Educational Research*, 76, 1-62.

- De Jong, R., Westerhof, K.J., & Creemers, B.P.M. (2000). Homework and student math achievement in junior high schools. *Educational Research & Evaluation, 6*, 130-157.
- Dettmers, S., Trautwein, U., & Ludtke, O. (2009). The relationship between homework time and achievement is not universal: Evidence from multilevel analyses in 40 countries. *School Effectiveness and School Improvement, 20*, 375-405. doi: 10.1080/09243450902904601
- Ellsasser, C. (2007). Do the math: Redesigning homework to create more time for learning. *Encounter, 20*, 20-24.
- Epstein, J.L. & Van Voorhis F. L. (2001) More than minutes: Teachers' roles in designing homework. *Educational Psychologist, 36*, 181-193.
- Goldstein, A. (1960). Does homework help? A review of research. *The Elementary School Journal, 60*, 212-224.
- Hyde, J. S., Else-Quest, N. M., Alibali, M. W., Knuth, E., & Romberg, T. (2006). Mathematics in the home: Homework practices and mother-child interactions doing mathematics. *Journal of Mathematical Behavior, 25*, 136-152. doi: 10.1016/j.jmathb.2006.02.003
- Keith, T. (1982). Time spent on homework and high school grades: A large-sample path analysis. *Journal of Educational Psychology, 74*, 248-253.
- Paschal, R.A., Weinstein, T., & Walberg, H.J. (2001). The effects of homework on learning: A quantitative synthesis. *Journal of Educational Research, 78*, 97-104.
- Shirvani, H. (2007). Effects of teacher communication on parents' attitudes and their children's behaviors at schools. *Education, 128*, 34-47.
- Trautwein, U., Koller, O., Schmitz, B., & Baumert, J. (2002). Do homework assignments enhance achievement? A multilevel analysis in 7th-grade mathematics. *Contemporary Educational Psychology, 27*, 26-50. doi:10.1006/ceps.2001.1084

- Trautwein, U. (2007). The homework-achievement relation reconsidered: Differentiating homework time, homework frequency, and homework effort. *Learning and Instruction, 17*, 372-388. doi:10.1016/j.learninstruc.2007.02.009
- Walberg, H. J., Paschal, R.A., & Weinstein, T. (1985). Homework's powerful effects on learning. *Educational Leadership, 42*, 76-79.
- Xu, Jianzhong. (2009). School location, student achievement, and homework management reported by middle school students. *The School Community Journal, 19*, 27-43.

Appendix A

Name _____

Pre-Survey

1) Please answer each of the following questions.

- Do you think students should receive homework in math? (Circle one.)
Yes No

2) What are some of the positive reasons for doing homework?

(Check all that apply.)

- Homework helps me learn.
 Homework helps me improve my organizational skills.
 Homework helps me improve my study skills.
 Homework gives me a chance to work on my own.
 Homework gives me a chance to work with my parents.
 Homework is interesting.

3) How often should homework be given? (Check one.)

- Every day
 Every other day
 Once a week
 Once a month
 Never

4) How long should students spend on their math homework each night? (Check one.)

- Less than 15 minutes
 15 minutes
 20 minutes
 30 minutes
 1 hour

5) How important do you feel it is to complete your homework? (1 is not important, 5 is very important)

1 2 3 4 5

6) How important do you feel it is that your homework is done correctly? (1 is not important, 5 is very important)

1 2 3 4 5

7) How important do you feel it is to fix the mistakes you make on your homework? (1 is not important, 5 is very important)

1 2 3 4 5

8) Do you think you are more likely to do well on your tests if you do well on your homework? (Circle one.)

Yes No

9) Do you think the grades on your homework are related to the grades on your tests? (Circle one.)

Yes No

Why or why not? _____

10) Do you think fixing the mistakes on your homework will help you do better on your tests? (Circle one.)

Yes No

Why or why not? _____

Appendix B

Name _____

Post-Survey

1) How important do you feel it is to complete your homework?
(1 is not important, 5 is very important)

1 2 3 4 5

2) How important do you feel it is that your homework is done correctly?
(1 is not important, 5 is very important)

1 2 3 4 5

3) How important do you feel it is to fix the mistakes you make on your homework?
(1 is not important, 5 is very important)

1 2 3 4 5

4) Do you think you are more likely to do well on your tests if you do well on your homework?
(Circle one.)

Yes No

5) Do you think the grades on your homework are related to the grades on your tests?
(Circle one.)

Yes No

Why or why not? _____

6) Do you think fixing the mistakes on your homework helped you do better on your tests?
(Circle one.)

Yes No

Why or why not? _____

Appendix C

Name _____

Math 7 - Surface Area Quiz

Find the Surface Area of each of the following.

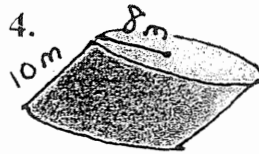
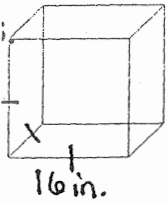
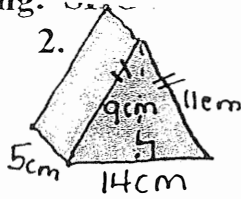
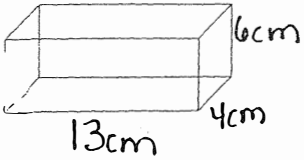

Answer each of the following. Show ALL Word problem steps and work!

1. Find the amount of paper needed to wrap the box to the right.

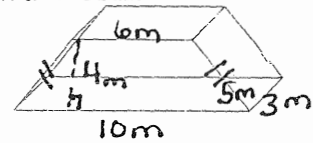

2. REVIEW OF AREA: Find the Area of each of the following. Show ALL Work!

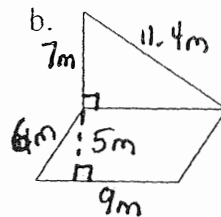
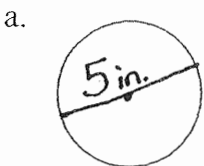

Appendix D

Name _____
 Date _____ Period _____

Unit: Geometry II
 Math 7 – Unit Test

Find the area of each of the following figures. Show all work!

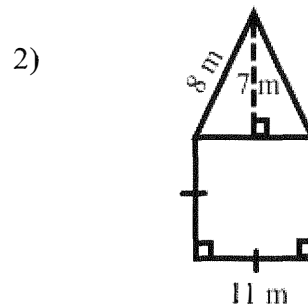
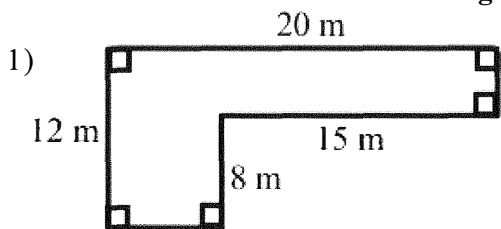

Find the area of the shaded region. Show all work!

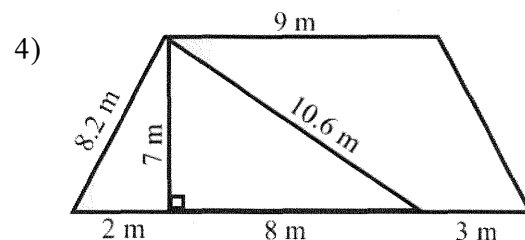
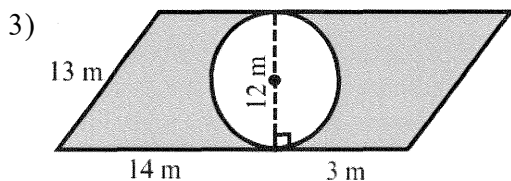

Find the volume of each figure. Show all work!

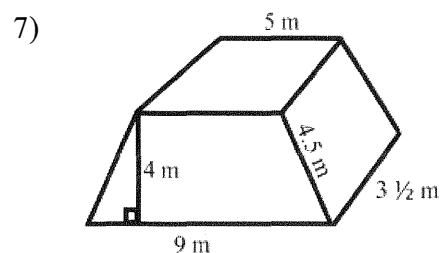
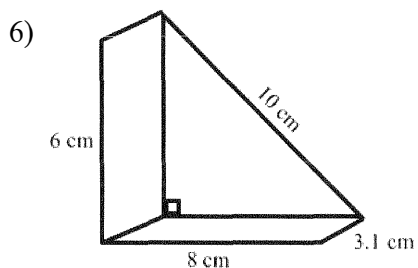
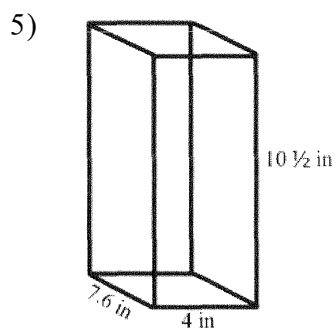

Find the surface area of each figure. Show all work!

8)

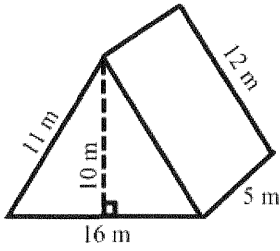

9)

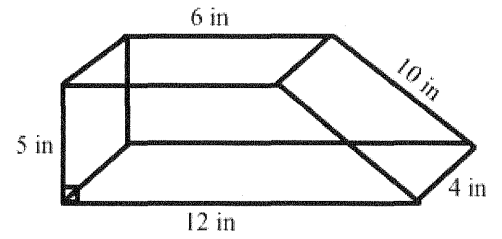

10)

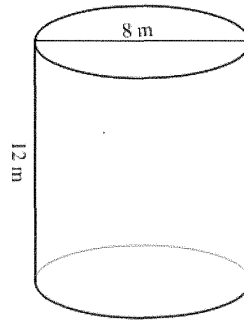

Solve for x . Show all work!

11)

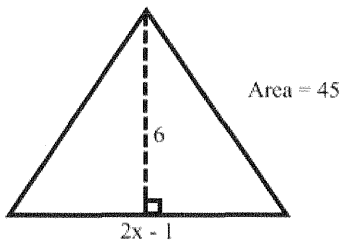

12)

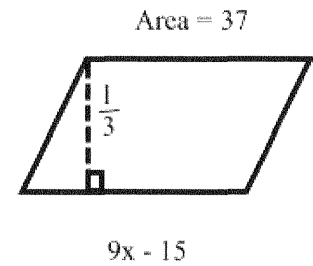

13) The area of a parallelogram is 28.6 m^2 and the base is 11 m. Find the height.

14) The area of a triangle is 84 square meters. If the base is 7 m, find the height of the triangle.

15) Find the amount of liquid that can fit in a can with a diameter of 11 cm and a height of 6 cm.

16) Amanda has to wrap two birthday gifts, which are in the boxes below. Which package will she need more paper for? **Why?**

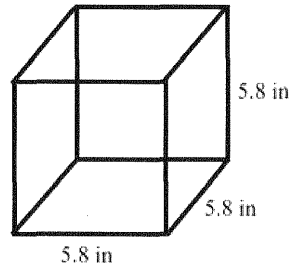
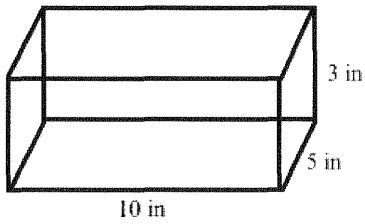

17) Find the perimeter of a square that has an area of 64 m^2 .

Check over your work!

Appendix E

Name _____
Date _____ Period _____

Unit: Ratios, Rates & Proportions
Math 7 – Quiz

State if each of the following is a ratio or a rate. Then, simplify.

1) $\frac{162 \text{ miles}}{4 \text{ hours}}$

2) $\frac{56 \text{ cars}}{72 \text{ cars}}$

Express each of the following as a unit rate.

3) 125 miles in 2 hours

4) 41 meters in 5 seconds

Solve each of the following proportions. Show all work!

5) - -

6) - -

7) - -

Which is the better buy? Justify your answer by showing the unit price for each.

8) 4 cans of tomato sauce for \$1.70 OR 5 cans of tomato sauce for \$2.05

Use a proportion to find the missing side in each pair of similar polygons.

9)

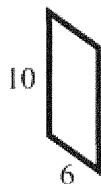
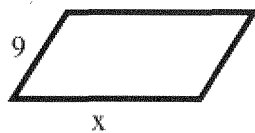

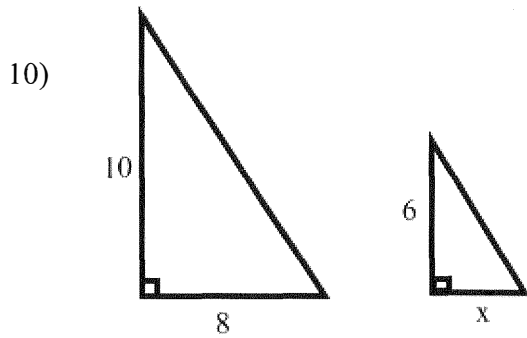

Solve each of the following using proportions. Show all work!

11) On a map, the scale is 1 inch represents 60 miles. Find the actual distance between two cities that are 1.3 inches apart.

12) If 9 kilograms of fertilizer will cover 300 m^2 of grass, how much fertilizer would be required to cover 500 m^2 ?

13) If a car uses 5 gallons of gasoline to travel 160 miles, how many gallons would the car use in traveling 96 miles?

14) If 5 folders cost \$0.70, how much will 8 folders cost?

Appendix F

Name _____

Date _____ Period _____

Unit: Percents
Math 7 - Unit Test: Part I

Show all work for each question. (Calculators may NOT be used!)

1) Change each of the following to a decimal.

a) $\frac{9}{25}$ _____

b) 46.7% _____

2) Change each of the following to a fraction in simplest form.

a) 78% _____

b) 0.56 _____

3) Change each of the following to a percent.

a) 0.065 _____

b) $\frac{7}{20}$ _____

Name _____

Unit: Percents

Date _____ Period _____

Math 7 - Unit Test: Part II

Use a proportion to solve. Show all work and label your answers! (Calculators may be used.)

1) What is 8% of 75?

2) 15 is what percent of 25?

3) What percent of 56 is 14?

4) 2 is 4% of what number?

5) Allie wants to adopt a puppy from the Lollipop Farm. When she calls, the employee tells her that 20% of the puppies have been adopted already. If there were 15 puppies there, how many puppies have been adopted already? How many puppies are left to adopt?

6) The Calkins Road field hockey team won 9 out of the 15 games in their season. What percentage of their games did they NOT win?

7) Larry sells cars at the Toyota dealership. If he earns a 20% commission, how much money in cars does he need to sell if he wants to earn \$60,000 a year?

8) Nathan works for a cell phone company and each time he gets someone to sign up for his service, he earns commission. If his sales totaled \$5,000 for his company and he earned \$400, what percent commission does he make?

9) Brooke missed 12 days of school last year. This year she only missed 5 days of school. What was the percent of change in the number of days she missed? Round your answer to the nearest tenth of a percent.

For each of the following, find the total cost of each item. Show all work and label your answers. Round answers to the nearest cent.

10) Jennifer buys a shirt for \$24.50 and a pair of pants for \$49.50. She has a coupon for 20% off her total purchase. If the sales tax is 8.5%, how much will Jennifer pay for her purchases?